



2023 Water Features
Product Catalog



You are reading this catalog digitally

which fits perfectly with our corporate green initiatives. We are all living in a connected world today which is why being able to escape to “Living the Aquascape Lifestyle®” where you live and often work, is more important than ever!

Nothing, and I mean nothing, will melt your stress away like the sound of water while feeding your fish and watching the birds take a bath in your stream. Ahhh ...”Living the Aquascape Lifestyle” personified!

Aquascape has been dedicated to improving the consumers' experience with water features for 32 years and counting. Still to this day, we are the only manufacturer of water feature equipment on the planet that builds and maintains water features every day with our own crews! We are able to “talk the talk, because we walk the walk.” We create the products we ourselves need as water feature artists and want as hobbyists!

As you scroll through this catalog you'll be immersed into a world to help people escape the stresses of this world. From Aquascape ecosystem ponds designed to “Work With Mother Nature, Not Against Her” to Pondless® Waterfalls that bring the sights and sounds of natural waterfalls to your living space and fountainscapes to fit whatever design element you're going for!

Please enjoy the labor of our love for all things decorative water feature related!

And welcome to “Living the Aquascape Lifestyle!”

*Greg Wittstock
The Pond Guy*

Greg Wittstock , The Pond Guy

Founder and CEO
Aquascape, Inc.



Table of Contents



Living the Aquascape Lifestyle®

We connect people to water the way nature intended. That's why we invented and patented an ecosystem approach to designing, building, and maintaining water features that relies on a natural balance of circulation, filtration, plants, fish, and rocks and gravel to ensure sustainability.

Our passion is to help you create your own personal paradise that incorporates a beautiful pond, waterfall, fountain - or any combination of these refreshing water features.

With decades of experience designing and field-testing water features and their products, you can rest assured that you're getting the best quality for the best value when you choose Aquascape. Flip through the pages of this catalog and be inspired to create your own personal paradise in your very own yard.

K	Kits	6
F	Filtration.....	26
P	Pumps	46
A	Aerators	70
L	Lighting.....	78
PA	Power Accessories.....	92
WT	Water Treatments	96
PC	Predator Control.....	122
SC	Seasonal Care	126
FC	Fish Care	132
APC	Aquatic Plant Care	140
D	Decorative	144
LUG	Liner, Underlayment, and Geotextile	180
PP	Pipe and Plumbing	186
IT	Installation Tools.....	194
RH	Rainwater Harvesting	200



How Smart Is Your Pond?

Control, schedule, and monitor your pond, waterfall, or fountain with Aquascape smart control products.



It's Easy As 1-2-3



- 1. Download** the Aquascape Smart Control App to your smartphone or tablet
- 2. Control** and schedule lights, pumps, fountains, and more
- 3. Monitor** your water temperature, power consumption, and devices, in real-time from anywhere in the world

aquascapeinc.com/smart-control-app

Aquascape Smart Control Products



Smart Pond Thermometer
[See page 129](#)



Smart Control Plug
[See page 95](#)



Smart Control Receiver
[See page 48](#)



Smart Control Hub
[See page 80](#)



Smart Pond Dosing System XT
[See page 102](#)

Dosing System SL

Compact dosing system automatically adds treatment to ponds, waterfalls, and fountains up to 2,000 gallons.

[See page 100](#)



SL Water Treatments

The same great Simple Solutions treatments in bottles for use with the Dosing System SL.

[See page 101](#)



Fire and Water Spillway Basin

Excite your senses with this CSA-approved, auto-ignite, fire and water feature. [See page 151](#)



AquaGarden Maintenance 4-in-1

This treatment is formulated specifically for use with Aquascape AquaGardens and other small container water gardens. This 4-in-1 formulation combines an ecosystem bacteria blend with special clarifiers, scale reducers, and foam reducers to keep your feature clean, clear, and maintenance free. [See page 116](#)



Faux Basalt Columns

Provide the natural look of Mongolian basalt columns at a fraction of the weight! [See page 158](#). Also available in a kit. [See page 25](#)



A lush backyard garden featuring a pond with a waterfall. The pond is surrounded by greenery, including lily pads and bright orange flowers. A decorative crane stands near the water's edge. In the foreground, a black Adirondack chair is partially visible. The background shows a wooden fence and trees.

Pond, Waterfall, and Fountain Kits

Transform your outdoor living space with an Aquascape pond, waterfall, or fountain kit. We've bundled the necessary components into convenient kits, making it easier than ever to create naturally balanced, low-maintenance water features.



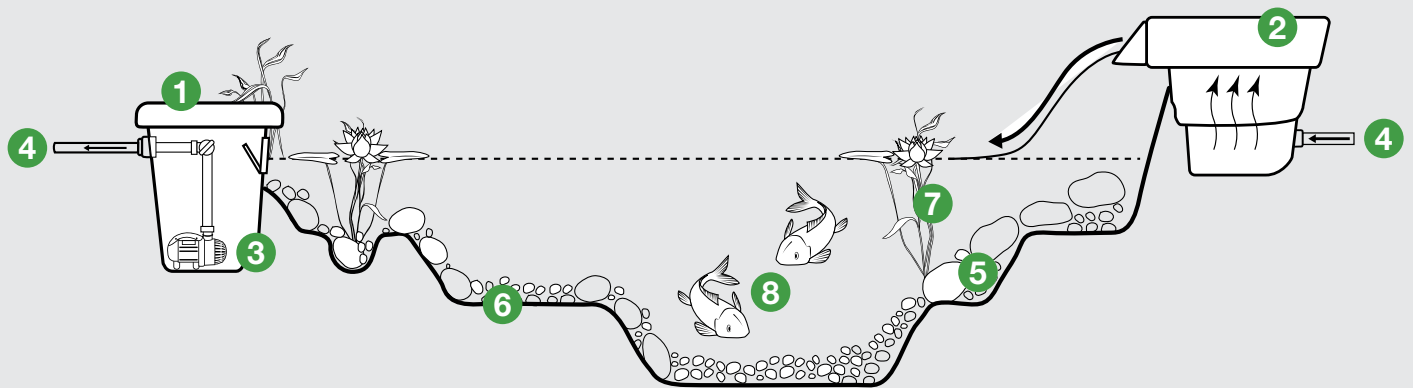

Features

- 1 Pond Skimmer**
Pre-filters water, houses pump, collects debris, and reduces maintenance
- 2 BioFalls® Filter**
Provides surface area for beneficial bacteria to colonize and remove excess nutrients from the water
- 3 Pond Pump**
Pumps water from the pond skimmer to the BioFalls Filter to create a waterfall
- 4 Pipe**
Directs water from the skimmer to the BioFalls Filter
- 5 Rocks and Gravel (not included)**
Protects the liner, naturalizes the pond bottom, and provides surface area for beneficial bacteria to break down excess nutrients
- 6 Pond Liner and Underlayment**
Forms the pond's foundation, containing the water and allowing gases to escape from beneath the pond
- 7 Plants (not included)**
Filter pond water, minimizing maintenance and improving water conditions
- 8 Fish (not included)**
Provide nutrients for pond plants and reduce maintenance

DIY Backyard Pond Kits

K



DIY Backyard Pond Kit 8' x 11' Shown

Compare Aquascape DIY Backyard Pond Kits

	4' x 6'	6' x 8'	8' x 11'
Item Number	99763	99764	99765
MSRP	\$1,899.98	\$2,149.98	\$2,279.98
Skimmer	Signature Series 200 Pond Skimmer		
BioFalls	Signature Series 1000 BioFalls		
BioBalls Filter Media	✓		
Pump	EcoWave 2000		
Pipe	Kink-Free 1.5" x 25'		
Liner Material	45 mil EPDM (Fish Safe)		
Liner Size	8' x 10'	10' x 12'	12' x 15'
Finished Pond Size*	4'L x 6'W x 2' Max Depth	6'L x 8'W x 2' Max Depth	8'L x 11'W x 2' Max Depth
Underlayment	80 sq. ft.	120 sq. ft.	180 sq. ft.
Installation Kit	✓		
Packaged Weight	71.5 lb.	85 lb.	105 lb.
Packaged Dimensions	34"L x 22"W x 23"H		

*May vary based on pond shape and rock size

Professional-Grade Pond Kits

Professional-Grade BioFalls®

Provide professional features such as ESA filter mats, rock tray, and water-tight plumbing connection

Professional-Grade Skimmer

Provides professional features such as rigid debris basket, high-quality filter mat, locking weir door, and more



Warm White Pond Lighting

Brings ponds to life at night (included with medium and large kits)

Pond Pump Options

Variety of pump options makes it easy to choose the perfect pump

Installation Components

Includes waterfall foam, silicone, and everything else needed for installation

Medium Pond Kit 11' x 16' Shown



All Professional-Grade Pond Kits Include:

Automatic Dosing System for Ponds with included Maintain for Ponds water treatment

- Automatically adds treatment throughout the day
- Helps keep ponds clean, clear, and healthy

[See page 104](#)

Professional-Grade Pond Kits

K

Compare Aquascape Ecosystem Pond Kits

	Small Pond Kit 8' x 11'	Medium Pond Kit 11' x 16'	Large Pond Kit 21' x 26'	Medium Deluxe Pond Kit 11' x 16'	Large Deluxe Pond Kit 21' x 26'
Item Number	53033	53034 53035	53036 53037 53063	53066	53067
MSRP	\$3,302.00	\$5,476.44 \$5,381.44	\$8,131.19 \$8,340.19 \$8,254.69	\$6,487.16	\$8,972.84
Skimmer	Signature Series 400 Pond Skimmer	Signature Series 1000 Pond Skimmer			
BioFalls	Signature Series 1000 BioFalls	Signature Series 2500 BioFalls	Signature Series 6000 BioFalls	Signature Series 2500 BioFalls	Signature Series 6000 BioFalls
BioFalls Rock Tray	✓				
BioBalls Filter Media	✓				
Pump	AquaSurge 3000	AquaSurge 2000-4000 (Kit #53034) 3-PL 3000 (Kit #53035)	AquaSurge 4000-8000 (Kit #53036) 9-PL 7000 (Kit #53037) SLD 5000-9000 (Kit #53063)	AquaSurge 2000-4000	AquaSurge 4000-8000
Pond Powerhead	—			✓	
Faux Driftwood 30"	—			✓	
Pipe	Flexible PVC 1.5" x 25'	Flexible PVC 2" x 25'	Flexible PVC 2" x 50'	Flexible PVC 2" x 25'	Flexible PVC 2" x 50'
Duel Union Check Valve 2.0	✓				
45 mil EPDM Liner	12' x 15'	15' x 20'	25' x 30'	15' x 20'	25' x 30'
Finished Pond Size*	8'L x 11'W x 2'D	11'L x 16'W x 2'D	21'L x 26'W x 2'D	11'L x 16'W x 2'D	21'L x 26'W x 2'D
Underlayment	180 sq. ft.	300 sq. ft.	750 sq. ft.	300 sq. ft.	750 sq. ft.
Lighting	—	LED Lighting Package		LED Color-Changing Lighting Package	
Automatic Dosing System	✓				
App/WIFI Connected	—	53034	53036 53063	✓	
Installation Kit	✓				
Packaged Weight	145 lb.	290 lb.	488 lb.	315 lb.	513 lb.
Packaged Dimensions	25"L x 40"W x 30"H	48"L x 40"W x 31"H Palletized	48"L x 40"W x 41"H Palletized	48"L x 40"W x 31"H Palletized	48"L x 40"W x 41"H Palletized

*May vary based on pond shape and rock size



Deluxe Pond Kits

Include enhancements to take your pond to the next level, including:

- Color-changing lighting system
- Smart control for pump and lights
- Faux Driftwood 30"
- Pond Powerhead



K | F | P | A | L | PWR | WT | PC | SC | FC | APC | D | LUG | PP | IT | RH

UNDER CONSTRUCTION

UNDER CON

Dive

into the World of Recreational
Ponds with Aquascape!

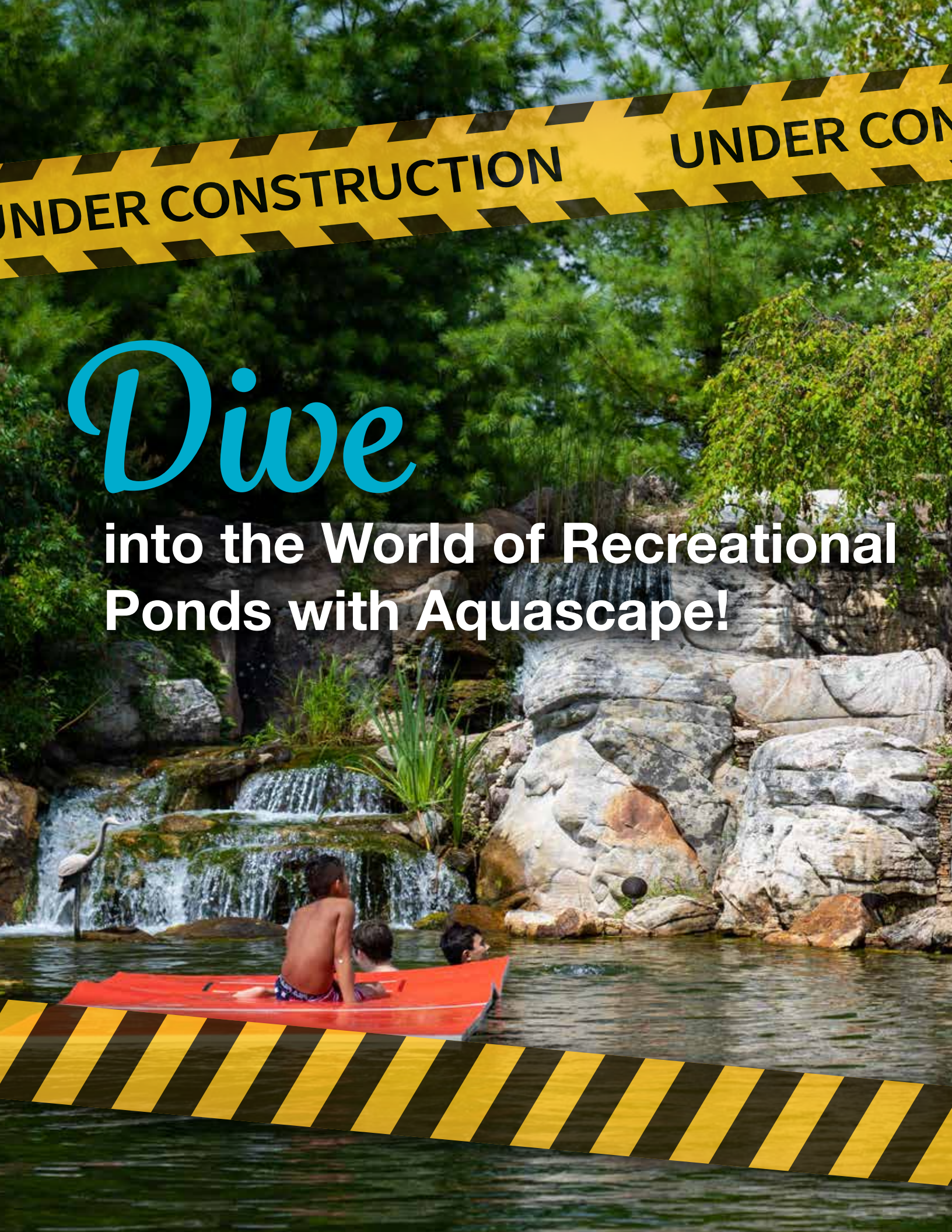

CONSTRUCTION UNDER CONSTRUCTION



Check back later for updates!



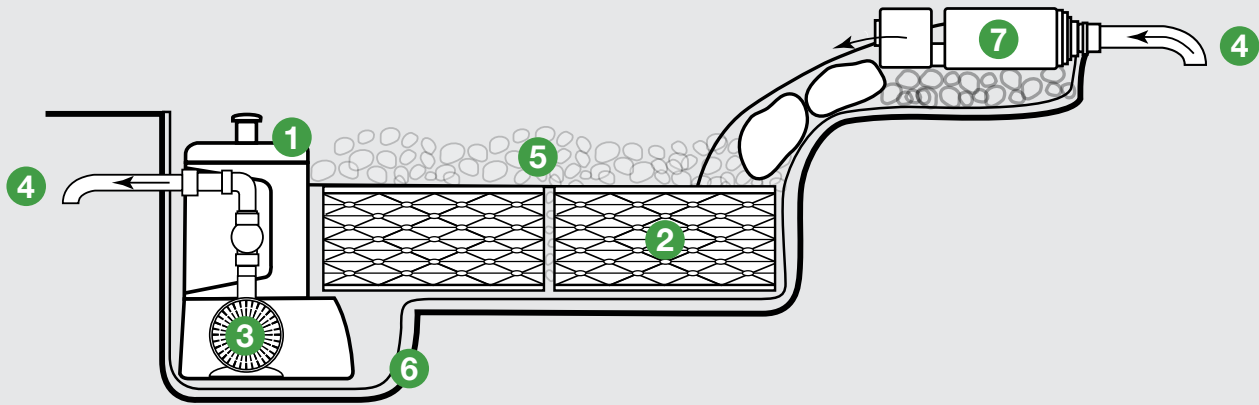

Features

- 1 Pondless® Waterfall Vault**
 Houses and protects pump
- 2 AquaBlox® Water Storage Modules**
 Provides water storage
- 3 Pond Pump**
 Pumps water from the underground reservoir to the spillway to create a waterfall
- 4 Pipe**
 Directs water from the basin/reservoir to the Waterfall Spillway
- 5 Rocks and Gravel (not included)**
 Naturalizes the waterfall, protects the liner, and filters the water
- 6 Liner and Underlayment**
 Creates the form of the waterfall and holds water in the water storage area
- 7 Waterfall Spillway**
 Provides a smooth, flowing waterfall

DIY Backyard Pondless® Waterfall Kit

K



DIY Backyard Waterfall Kit Shown

DIY Backyard Pondless Waterfall Kit

Item Number	83001
MSRP	\$1,899.98
Waterfall Spillway	✓
Pondless® Waterfall Vault	✓
AquaBlox®	(2) Small
Pump	EcoWave 2000
Pipe	Kink-Free 1.5" x 25'
Liner Material	45 mil EPDM (Fish Safe)
Liner Size	10' x 12'
Underlayment	105 sq. ft.
Installation Kit	✓
Waterfall and Stream Size*	3'
Packaged Weight	113 lb.
Packaged Dimensions	41"L x 20"W x 25"H

*May vary based on shape and rock size

K | F | P | A | L | PWR | WT | PC | SC | FC | APC | D | LUG | PP | IT | RH

Professional-Grade Pondless® Waterfall Kits

Pondless® Waterfall Vault

Extremely durable with quick and easy pump access

AquaBlox Water Storage Modules

Provide the ideal water storage capacity for each kit size

Flexible PVC Pipe

High-quality, durable, and easy to install



Warm White Pond Lighting

Brings ponds to life at night (included with medium and large kits)

Pond Pump Options

Variety of pump options makes it easy to choose the perfect pump

Medium Pondless Waterfall Kit 16" Stream Shown



All Professional-Grade Pondless® Waterfall Kits Include:

Automatic Dosing System with included Prevent for Fountains water treatment

- Automatically adds treatment throughout the day
- Helps keep waterfall clean, clear, and healthy

[See page 104](#)

Professional-Grade Pondless® Waterfall Kits

K

Compare Aquascape Pondless® Waterfall Kits

	Small Pondless Waterfall Kit (6' Stream)	Medium Pondless Waterfall Kit (16' Stream)	Large Pondless Waterfall Kit (26' Stream)	Medium Deluxe Pondless Waterfall Kit (16' Stream)	Large Deluxe Pondless Waterfall Kit (26' Stream)
Item Number	53038	53039 53040 53064	53041 53042 53065	53068	53069
MSRP	\$3,069.28	\$4,095.17 \$4,000.17 \$4,180.67	\$5,274.09 \$5,274.09 \$5,397.59	\$4,656.58	\$5,921.00
Waterfall Spillway			✓		
Pondless® Waterfall Vault			✓		
AquaBlox® Water Storage	(3) Small	(5) Small	(5) Large	(5) Small	(5) Large
Pump	AquaSurge 2000-4000	AquaSurge 2000-4000 (Kit #53039) 3-PL 3000 (Kit #53040) SLD 4000-7000 (Kit #53064)	AquaSurge 4000-8000 (Kit #53041) 5-PL 5000 (Kit #53042) SLD 5000-9000 (Kit #53065)	AquaSurge 2000-4000	AquaSurge 4000-8000
Faux Driftwood 35"		—		✓	
Pipe	Flexible PVC 1.5" x 25'	Flexible PVC 2" x 25'	Flexible PVC 2" x 50'	Flexible PVC 2" x 25'	Flexible PVC 2" x 50'
Duel Union Check Valve 2.0			✓		
45 mil EPDM Liner	10' x 10' (Reservoir) 8' x 10' (Stream)	10' x 12' (Reservoir) 10' x 20' (Stream)	10' x 15' (Reservoir) 10' x 30' (Stream)	10' x 12' (Reservoir) 10' x 20' (Stream)	10' x 15' (Reservoir) 10' x 30' (Stream)
Underlayment	100 sq. ft.	120 sq. ft.	180 sq. ft.	1200 sq. ft.	180 sq. ft.
Lighting	—	LED Lighting Package		LED Color-Changing Lighting Package	
Automatic Dosing System			✓		
App/WIFI Connected	✓	53039 53064	53041 53065		✓
Installation Kit			✓		
Packaged Weight	149 lb.	298 lb.	379 lb.	323 lb.	404 lb.
Packaged Dimensions	37"L x 24"W x 28"H	48"L x 40"W x 24"H Palletized	48"L x 40"W x 31"H Palletized	48"L x 40"W x 24"H Palletized	48"L x 40"W x 31"H Palletized



Deluxe Pondless® Waterfall Kits

Includes enhancements to take your waterfall to the next level:

- Color-changing lighting system
- Smart control for pump and lights
- Faux Driftwood 30"



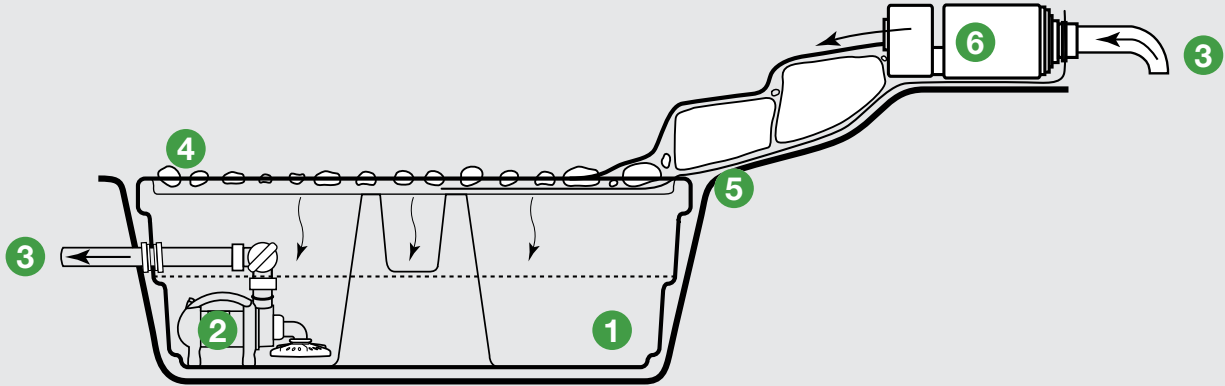

Features

- 1 AquaBasin® 45**
Provides a reservoir for water storage and protects the pump
- 2 Pond Pump**
Pumps water from the AquaBasin® to the spillway to create a waterfall
- 3 Pipe**
Directs water from the basin to the spillway
- 4 Rocks and Gravel (not included)**
Naturalizes the waterfall and filters the water
- 5 Liner and Underlayment**
Creates the form of the waterfall and stream
- 6 Waterfall Spillway**
Provides a smooth, flowing waterfall

Backyard Waterfall Landscape Fountain Kit



Backyard Waterfall Landscape Fountain Kit Shown

Aquascape Backyard Waterfall Landscape Fountain Kit

Aquascape Backyard Waterfall Landscape Fountain Kit	
Item Number	83013
MSRP	\$1,899.98
Waterfall Spillway	12"
Reservoir	AquaBasin® 45
Pump	AquaSurge 2000 with Low Suction Intake Attachment
Pipe	Flexible PVC 1.5" x 15'
Liner Material	45 mil EPDM (Fish Safe)
Liner Size	7.5' x 7.5'
Underlayment	(2) 7.5' x 1'
Installation Kit	✓
Waterfall and Stream Size*	3'
Packaged Dimensions	48"L x 40"W x 35"H Palletized

*May vary based on shape and rock size

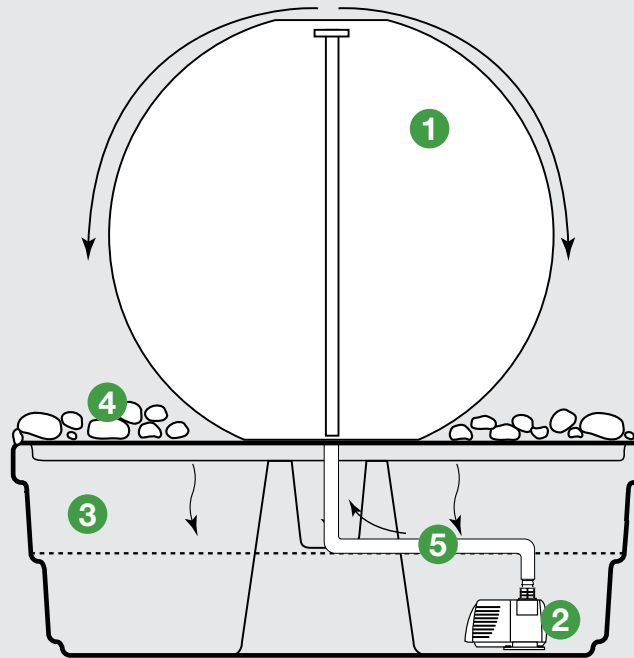

Features

- 1 Fountain**
One of the many fountain options
- 2 Pump**
Pumps water from the AquaBasin® through the fountain
- 3 AquaBasin® 45**
Provides a reservoir for water storage
- 4 Rocks and Gravel (not included)**
Disguises the AquaBasin and naturalizes the water feature
- 5 Pipe**
Directs water from the basin to the fountain

Fountain
Fiber-resin, GFRC, and natural stone options available

Pipe
Silicone or kink-free pipe included



Pump
Ultra Water Pump provides ideal water flow for each fountain

AquaBasin® 45
Heavy-duty reservoir stores up to 98 gallons of water

Medium Stacked Slate Sphere Landscape Fountain Kit Shown



Add Beauty And Elegance To Your Fountain

Bring your fountain to life at night with [Aquascape lighting options](#). See page 78-91

Landscape Fountain Kits



Medium Stacked
Slate Urn



Medium
Scalloped Urn

Item Number	58090	78270
MSRP	\$2,099.98	\$2,099.98
Material	Fiber-Resin Composite	
Pump	Ultra 1100 Water Pump	
Pipe	3/4" Silicone Tubing	
Packaged Weight	180 lb.	145 lb.
Packaged Dimensions	40"L x 48"W x 54"H	40"L x 48"W x 52"H

Landscape Fountain Kits

K



Medium Stacked
Slate Sphere



Stacked Slate
Spillway Wall 32"



Spillway Bowl
and Basin

Item Number	78290	78269	58087
MSRP	\$2,199.98	\$2,199.98	\$2,999.98
Material	Fiber-Resin Composite		GFRC
Pump	Ultra 1500 Water Pump	Ultra 2000 Water Pump	
Pipe	3/4" Silicone Tubing	(3) 3/4" Silicone Tubing	Pre-Cut Kink-Free 3/4" x 12.5'
Packaged Weight	195 lb.	157 lb.	380 lb.
Packaged Dimensions	40"L x 48"W x 46"H	40"L x 48"W x 54"H	40"L x 48"W x 66"H

K | F | P | A | L | PWR | WT | PC | SC | FC | APC | D | LUG | PP | IT | RH



Stone Basalt Fountain Kit

Create an impressive, recirculating, stone fountain with the Mongolian basalt columns. Each stone is core-drilled making installation easy. You'll enjoy the look and feel of real stone while watching water cascade beautifully over the sides of your fountain.



Mongolian Basalt Columns Set of 3

Item Number	58089
MSRP	\$3,899.98
Material	Natural Stone
Pump	Ultra 2000 Water Pump
Pipe	Pre-Cut Kink-Free 3/4" x 15'
Packaged Weight	963 lb.
Packaged Dimensions	40"L x 48"W x 31"H



Faux Basalt Column Landscape Fountain Kit

The Aquascape Faux Basalt Column Set of 3 Landscape Fountain Kit bundles the perfect combination of products, providing everything needed to create an impressive, recirculating, three-piece faux basalt fountain. Each column is molded from real basalts and handmade in the USA using fiberglass, resin, and real stone to provide an extremely realistic and durable fountain. Three columns are included, measuring 24 inches, 30 inches, and 36 inches in height.



Faux Basalt Columns Set of 3

Item Number	78366
MSRP	\$2,999.98
Material	Fiber-Resin Composite
Pump	Ultra 2000 Water Pump
Pipe	Flexible Tubing 3 pcs.
Packaged Weight	185 lb.
Packaged Dimensions	40"L x 48"W x 31"H

NOTE: Faux Basalt Columns not compatible with Fire and Water Torches

Pond and Waterfall Filtration

To keep your pond or water feature looking beautiful, it is important to provide proper filtration.





Skimmer Filters

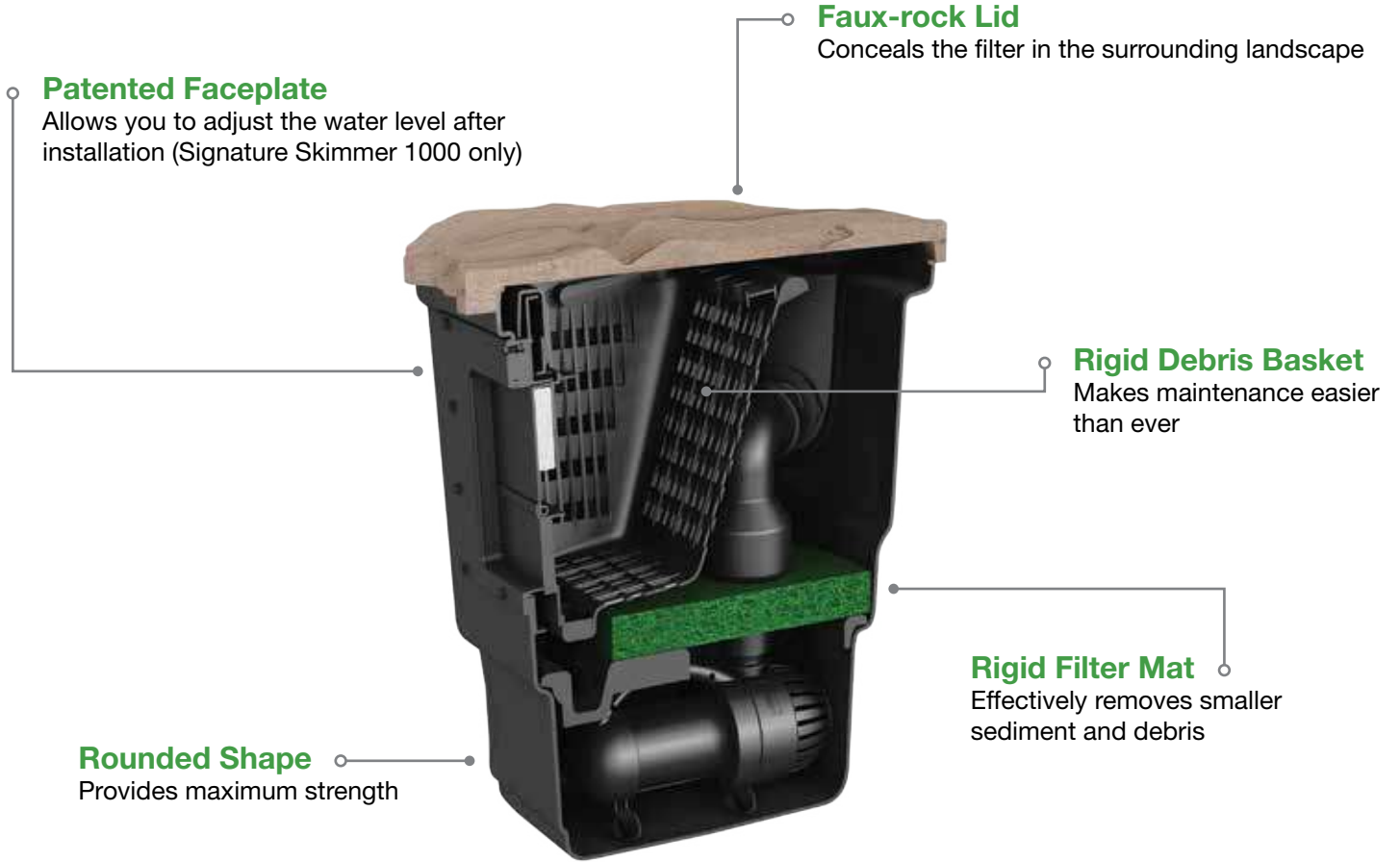

Signature Series 1000 Pond Skimmer Shown

Pond Skimmers are an integral component to a balanced ecosystem pond. Pond skimmers continuously sweep the surface of the water, drawing in leaves and floating debris to reduce maintenance and keep water clean.

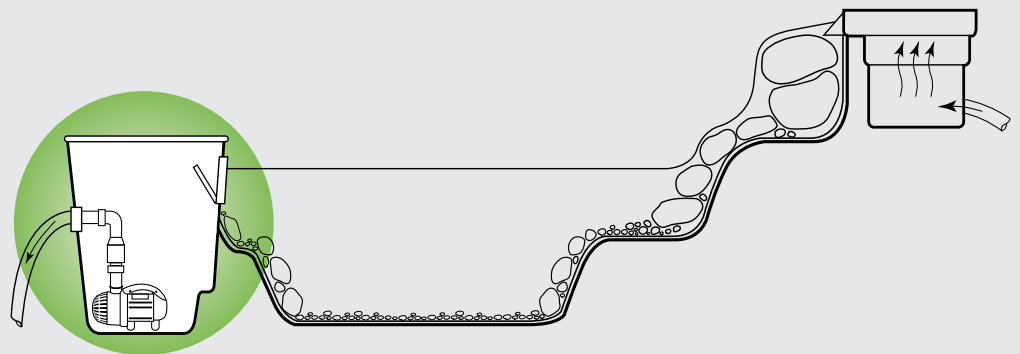

Compare Aquascape Skimmers



Signature Series 200
Pond Skimmer



Signature Series 400
Pond Skimmer



Signature Series 1000
Pond Skimmer

U.S. Patent 7,144,501

Item Number	43020	43021	43022
MSRP	\$589.98	\$759.99	\$1,039.99
Pond Size	Up to 200 sq. ft.	Up to 400 sq. ft.	Up to 1,000 sq. ft.
Pump Flow Rate	Up to 3,000 GPH / 11,500 LPH	Up to 4,000 GPH / 15,000 LPH	Up to 10,000 GPH / 38,000 LPH*
Recommended Pumps	EcoWave and AquaSurge Pumps	EcoWave, AquaSurge, AquaSurge Adjustable Flow, and PL Pumps	EcoWave, AquaSurge, AquaSurge and SLD Adjustable Flow, and PL Pumps
Weir Size	6"		8"
Adjustable Height Face Plate	—		✓
Locking Weir Door	—	✓	
Debris Net/Basket	Net	Rigid Basket	
Filter Brush Cartridge	Optional	—	
Overflow	Optional	✓	
Filter Mat	—	✓	
Faux-Rock Lid	—	✓	
Dimensions	20"L x 17.5"W x 17.5"H	21.4"L x 18"W x 21"H	21"L x 22"W x 26.5"H
Warranty	Limited Lifetime		
Packaged Weight	14.75 lb.	25 lb.	34 lb.
Packaged Dimensions	22.5"L x 20"W x 18.5"H	25.75"L x 20.5"W x 25"H	25"L x 24"W x 26.75"H

Note: 12PN-10,000 and AquascapePRO 10,000 pumps are too large to fit in these skimmers. Multiple pumps can be used to achieve up to 10,000 gallons per hour.

BioFalls® Filters

Reversible Waterfall Lip

Provides the option of using a natural stone spillway

Removable Rock Tray

Holds rocks, plants, and gravel to help hide the filter in the landscape

Filter Media Net

Holds biological filtration media such as BioBalls, sold separately. [See page 36](#)

Biological Filter Mats

Two Poly-Flo ESA biological filter mats provide 50% more surface area than traditional mats

Circular Shape

Provides superior strength and durability



Signature Series 6000 BioFalls® Filter Shown

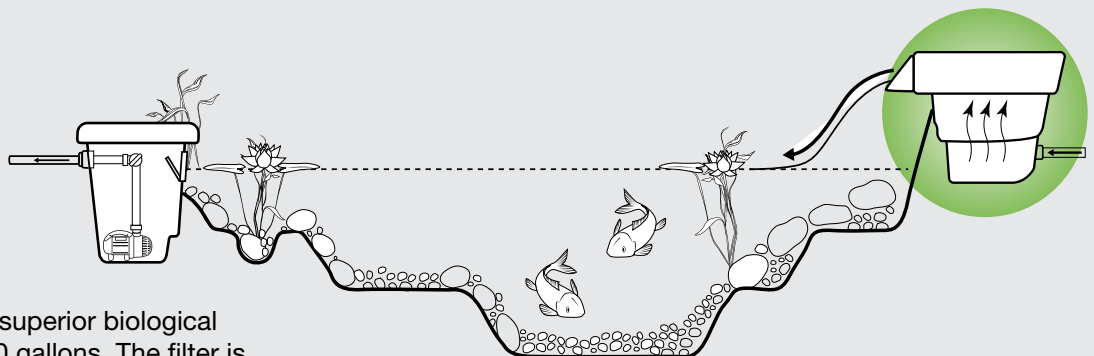

Aquascape BioFalls provide superior biological filtration in ponds up to 6,000 gallons. The filter is easily concealed into the landscape and creates the perfect start of a waterfall or stream.

Compare BioFalls® Filters



Signature Series
1000 BioFalls



Signature Series
2500 BioFalls



Signature Series
6000 BioFalls
with 2" Bulkhead



Signature Series
6000 BioFalls
with 3" Bulkhead

Item Number	99774	09020	29319	29384
MSRP	\$649.98	\$1,059.99	\$1,689.99	\$1,899.99
Filters Ponds up to	1,000 gal. / 3,800 L	2,500 gal. / 9,500 L	6,000 gal. / 22,700 L	
Pump Flow Rate	Up to 3,000 GPH / 11,400 LPH	Up to 5,000 GPH / 18,900 LPH	Up to 15,000 GPH / 56,800 LPH	
Spillway Width	15"	21.5"	28"	
Bulkhead Port	Single 2"	Dual 2"		Dual 3"
Fittings Included	1.5" PVC slip and 1.5" kink-free insert	Two 2" PVC slip		Two 3" PVC slip
Rock Tray	Sold Separately (#98285)	✓		
Filter Mats	(2) Standard	(2) Poly-Flo ESA		
BioBalls	Sold Separately (#98464)			
Minimum BioBalls Quantity	100	200	400	
Filter Media Nets	1 Included	2 Included	3 Included	
Dimensions	17.5"L x 20.5"W x 17"H	24"L x 29.5"W x 20"H	40"L x 45"W x 29.5"H	
Warranty	Limited Lifetime			
Packaged Weight	11 lb.	28.8 lb.	55 lb.	57 lb.
Packaged Dimensions	18.5"L x 20.5"W x 17.5"H	30"L x 24"W x 24"H	40"L x 45"W x 29.5"H	

Add-On Pond Filters

Ideal DIY Solution

Easy and cost-effective way to add filtration to small ponds



Pond Waterfall Filter Shown

Decorative Housing

Easily concealed at the edge of the pond



Small Pond Filter Urn Shown

Compare Add-On Filters



Pond Waterfall Filter



Small Pond Filter Urn



Large Pond Filter Urn

Item Number	77020	77006	77011
MSRP	\$129.98	\$259.98	\$519.98
Pond Volume	1,000 gal.	500 gal.	1,500 gal.
Maximum Flow Rate	5,000 GPH / 18,500 LPH	400 GPH / 1,500 LPH	1,100 GPH / 4,000 LPH
Inlet Fitting Dimensions	1", 1.25", 1.5"	1/2"	3/4"
Filter Dimensions	20"L x 15"W x 12.5"H	20"L x 11"W x 11"H	28"L x 15.5"W x 15.5"H
Warranty	5-Year Limited	1-Year Limited	
Packaged Weight	11 lb.	16.1 lb.	25 lb.

Cage and Filter Sponge
Effectively capture debris before it enters the filter or pump



Ceramic Filtration Rings
Clean water using biological filtration

Adjustable Spray Bar
Creates surface movement and oxygenation



Submersible Pond Filter Shown

Container Water Garden Filter Shown

Compare Add-On Filters



Submersible Pond Filter



Container Water Garden Filter

Item Number	95110	77005
MSRP	\$103.98	\$45.98
Pond Volume	Up to 800 gal.	Up to 50 gal.
Recommended Pump	Ultra 1100 Water Pump (#91008)	—
Fittings Included	3/4", 1", 1.25"	Multiple Fittings Included
Filter Dimensions	13"L x 11"W x 5"H	2"L x 1.5"W x 7"H
Warranty	3-Year Limited	1-Year Limited
Packaged Weight	11 lb.	1 lb.
Packaged Dimensions	12"L x 6"W x 12.75"H	4.25"L x 3.25"W x 8"H

Filter Media

Popular Media

Used in skimmer and biological filters

10' Long and 56" Wide
Easily cut to desired size/shape



Coarse Filter Media Roll Shown

Compare Filter Rolls and Mats



Dense Filter Media Roll
1" Thick

Coarse Filter Media Roll
1.25" Thick

Coarse Filter Media Roll
2" Thick

Item Number	99325	99321	99323
MSRP	\$311.98	\$363.98	\$454.98
Packaged Weight	8.75 lb.	8.25 lb.	10 lb.
Packaged Dimensions	10'L x 56"W		

Rigid Filter Media Mats
Provides efficient mechanical and biological filtration for your pond

Three Options
Available in 3 different densities

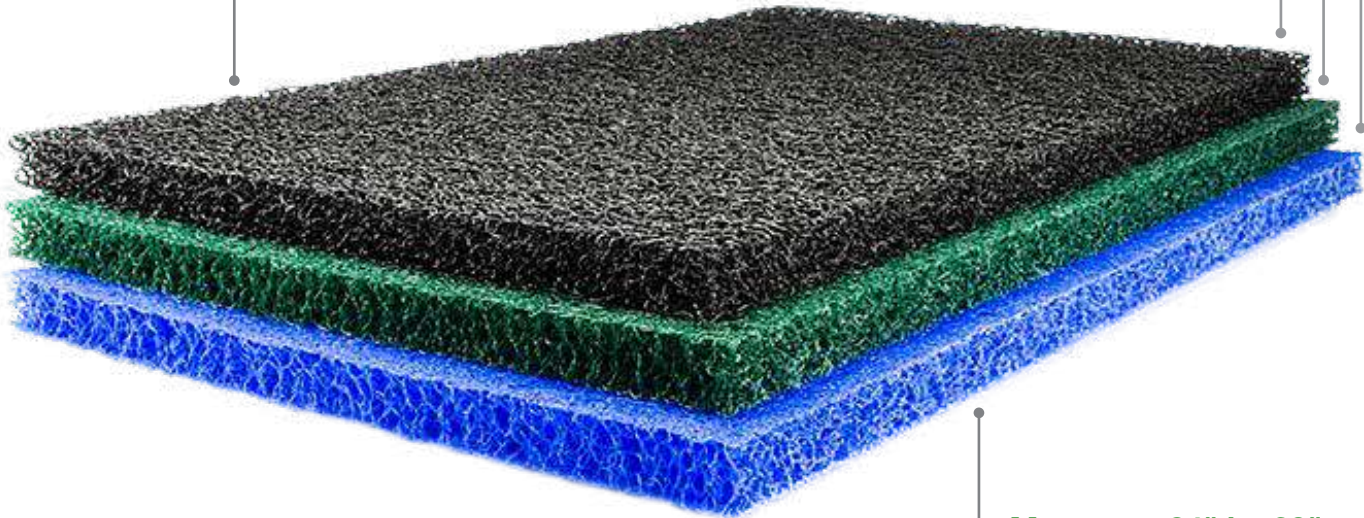

Measures 24" by 39"
Easily cut to desired shape/size

Compare Filter Rolls and Mats



Low Density Rigid Filter Mat
1.5" Thick

Medium Density Rigid Filter Mat
1.5" Thick

High Density Rigid Filter Mat
1.5" Thick

Item Number	80003	80004	80005
MSRP	\$71.98	\$71.98	\$77.98
Packaged Weight	4.25 lb.	3.5 lb.	3.25 lb.
Packaged Dimensions	24" x 39"W		

Filter Media

Keeps Ponds Clean

Provides textured surface area for beneficial bacteria to clean the water

Center Channel

Allows the balls to be strung together making cleaning easier

Compact Size

Allows for placement into smaller areas

Paddle Wheel Design

Helps to de-gas and aerate water

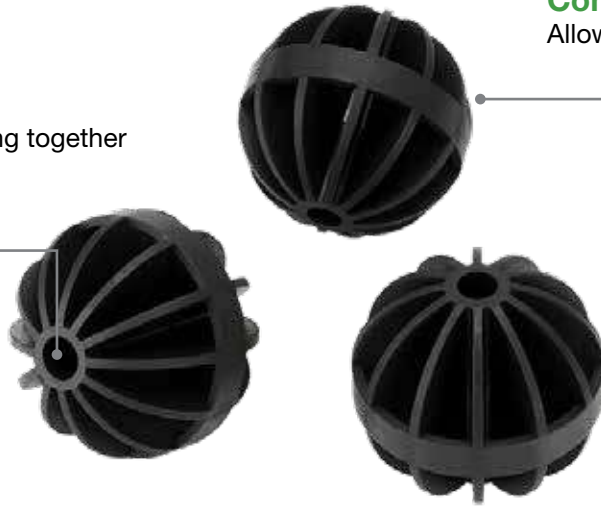

Ideal Filter Media

Easy to clean, long lasting, and lightweight

BioBalls Biological Filter Media Shown



BioBalls Biological Filter Media
100 Count



BioBalls Biological Filter Media
1,000 Count



BioBalls Filter Media Net

Item Number	98464	56014	29069
MSRP	\$99.98	\$506.98	\$20.98
Count	100 BioBalls	1,000 BioBalls	1 Net
Size	1.5" Diameter		24" x 28"
Media Net	Included	Sold Separately	—
Packaged Weight	2.25 lb.	24 lb.	.25 lb.
Packaged Dimensions	8"L x 8"W x 6.5"H	18"L x 12"W x 14"H	7.25"L x 10.5"W x 1"H

UltraKlear® UV Clarifier

F

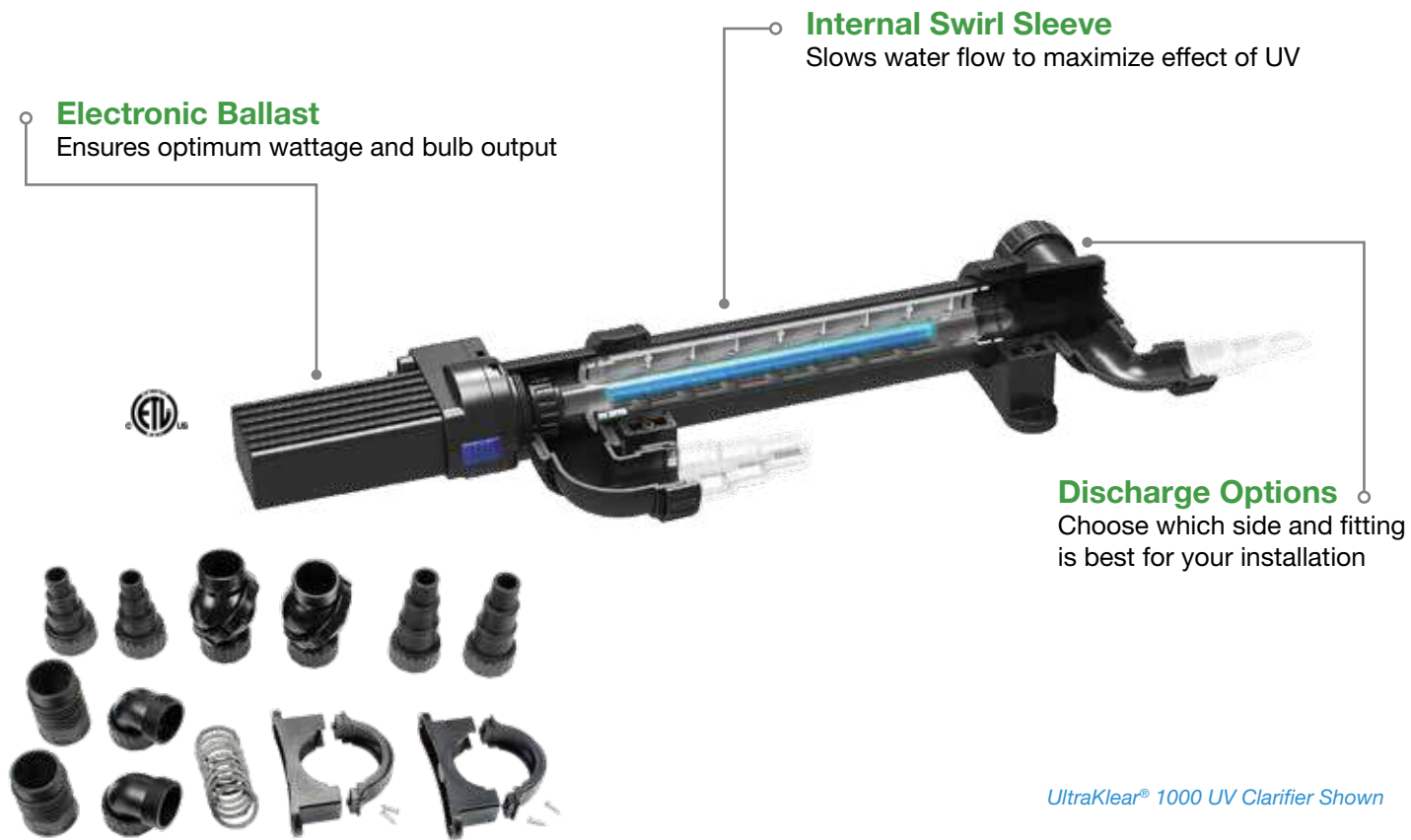

Compare UltraKlear UV Clarifier

	UltraKlear 1000	UltraKlear 2500	UltraKlear 5000
Item Number	95036	95037	95038
MSRP	\$319.98	\$379.98	\$479.98
Average Pond Size Recommendation	1,000 gal. / 3,500 L	2,500 gal. / 9,000 L	5,000 gal. / 18,500 L
Max Flow Rate	500 GPH / 1,500 LPH	1,000 GPH / 3,500 LPH	1,500 GPH / 5,500 LPH
UV Wattage	14	28	55
Power Cord Length	20'		
Discharge Hose Diameter	1", 1.25", 1.5"		
Dimensions	23.5"L x 5.5"W x 3.75"H	33.5"L x 5.5"W x 3.75"H	43"L x 5.5"W x 3.75"H
Warranty	3-Year Limited		
Packaged Weight	6.5 lb.	8.75 lb.	10 lb.
Packaged Dimensions	24"L x 11"W x 4"H	34"L x 9.5"W x 4"H	44.5"L x 9.5"W x 4"H

K | F | P | A | L | PWR | WT | PC | SC | FC | APC | D | LUG | PP | IT | RH

UltraKlean™ Pond Filters



Compare UltraKlean™ Pond Filters

	UltraKlean 2000	UltraKlean 3500
Item Number	95053	95054
MSRP	\$509.98	\$639.98
Average Pond Size Recommendation	2,000 gal. / 7,500 L	3,500 gal. / 13,000 L
Max Flow Rate	2,700 GPH / 10,000 LPH	5,200 GPH / 19,500 LPH
UV Wattage	14	28
Power Cord Length	20'	
Discharge Hose Diameter	1", 1.25", 1.5"	
Dimensions	13"L x 13"W x 17"H	13"L x 13"W x 21.5"H
Warranty	3-Year Limited	
Packaged Weight	17 lb.	22 lb.
Packaged Dimensions	14"L x 14"W x 18"H	14"L x 14"W x 22.5"H

UltraKlean™ Pond Filter Kits

F



UltraKlean™ 2500 Pond Filtration Kit Shown

Compare UltraKlean™ Pond Filter Kits

	UltraKlean 1500 Kit	UltraKlean 2500 Kit	UltraKlean 3500 Kit
Item Number	95058	95059	95060
MSRP	\$999.98	\$1,099.98	\$1,449.98
Average Pond Size Recommendation	Up to 1,500 gal. / 5,500 L	Up to 2,500 gal. / 9,000 L	Up to 3,500 gal. / 13,000 L
Filter Model	UltraKlean 2000		UltraKlean 3500
UV Clarifier	14		28
Included Pump	AquaForce® 1000	AquaForce® 2700	AquaForce® 5200
Pipe	Kink-Free 1.5" x 25'		
Stainless Steel Clamps	4	4	7
2-Way Flow Control Valve	—		✓
Packaged Weight	39.75 lb.	40 lb.	48.5 lb.
Packaged Dimensions	23.5"L x 21.5"W x 21"H	23.5"L x 21.5"W x 22.5"H	23.5"L x 21.5"W x 23.5"H

K | F | P | A | L | PWR | WT | PC | SC | FC | APC | D | LUG | PP | IT | RH

Waterfall Spillway

Wide Opening
Handles high flow rates

Watertight Connection
Professional, leak-free plumbing hook-up



Internal Barriers
Diffuse the water into a smooth-flowing waterfall

Waterfall Spillway 22" Shown

Compare Waterfall Spillways

	Waterfall Spillway 12"	Waterfall Spillway 22"
Item Number	77023	77000
MSRP	\$269.99	\$324.99
Bulkhead Port	Single 2"	
Fittings Included	2"PVC Slip, and 1.5" Barbed Hose Fitting	
Maximum Flow Rate	4,000 GPH / 15,000 LPH	7,500 GPH / 28,000 LPH
Dimensions	10.5"L x 14"W x 5"H	17.5"L x 24"W x 5"H
Packaged Weight	4.5 lb.	9 lb.
Packaged Dimensions	14"L x 15"W x 5.5"H	24"L x 17"W x 5"H

The Waterfall Spillway provides the ideal starting point for waterfalls and streams, using strategically-positioned internal barriers to diffuse the water and optimize the flow.

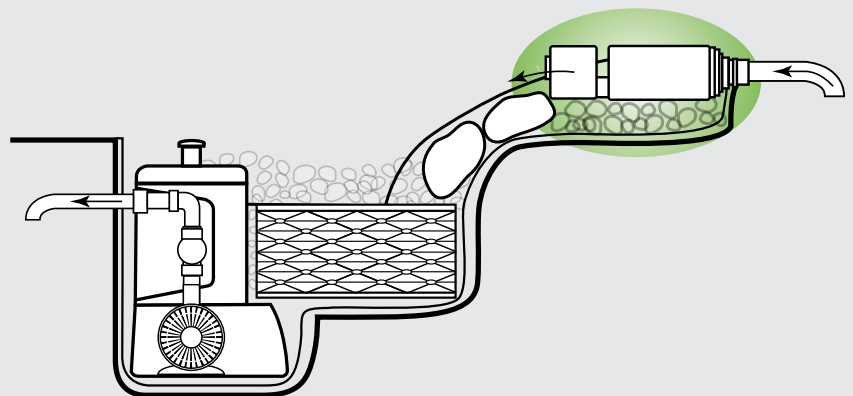

Pondless® Waterfall Vault



Inspection Port
Quickly check water levels without removing the lid

Large Interior
Fits a wide range of pump sizes

Water Intakes
Optimize water circulation



Vault Extension
Increases vault height for deeper applications



	Pondless® Waterfall Vault	Pondless® Waterfall Vault Extension
Item Number	49000	49001
MSRP	\$545.99	\$155.99
Maximum Flow Rate	Up to 12,500 GPH / 47,000 LPH	—
Access Opening Dimensions	16"L x 16"W	
Dimensions	23"L x 17"W x 25.5"H	16"L x 16"W x 9"H
Packaged Weight	14 lb.	5 lb.
Packaged Dimensions	23"L x 18"W x 22.5"H	16"L x 16"W x 10"H

The vault is designed to integrate with Aquascape AquaBlox, effectively protecting pumps while making installation quick, precise, and simple. Its durable, rotationally molded, rounded polyethylene shape structural strength fits a wide range of pump sizes.

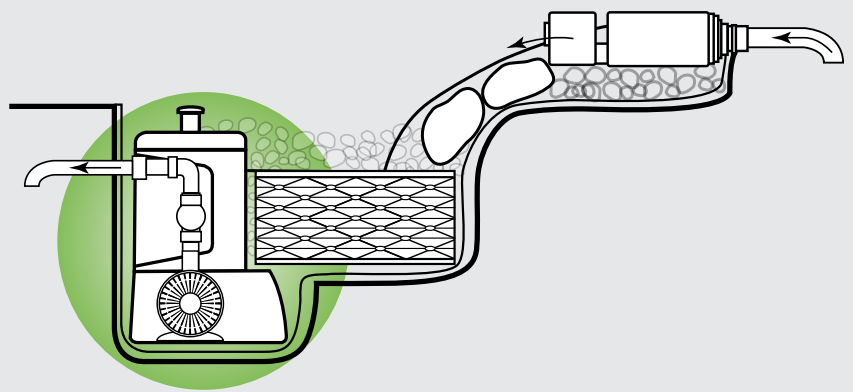

AquaBlox® Water Storage Modules

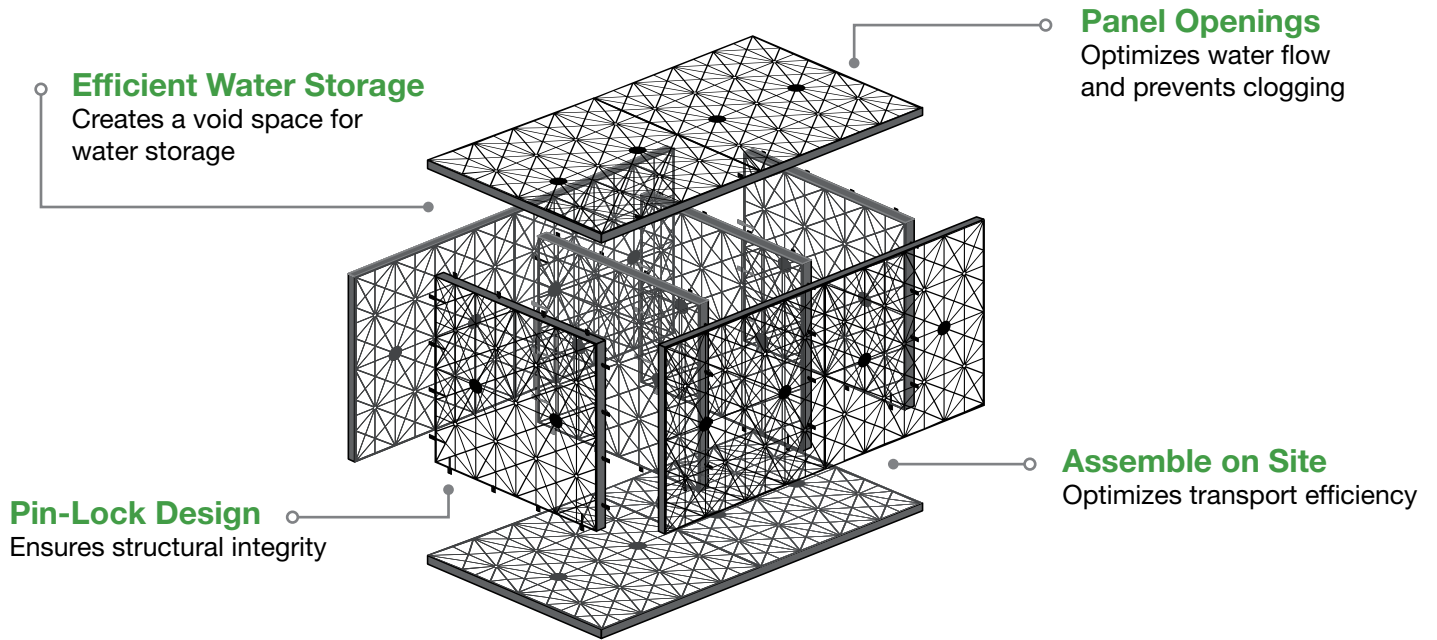

Compare AquaBlox® Water Storage Modules

	Small	Large
Item Number	29491	29492
MSRP	\$77.99	\$94.99
Volume	17 gal. / 64.35 L	32 gal. / 121.13 L
Load Bearing Weights	5,472 lb./sq. ft.	
Dimensions	26.5"L x 16"W x 9.5"H	26.5"L x 16"W x 17.5"H
Packaged Weight	11 lb.	16 lb.
Packaged Dimensions	27"L x 16"W x 4"H	27"L x 16"W x 6"H

Aquascape AquaBlox® Water Storage Modules provide structural void space for water storage in Pondless® Waterfalls, rainwater collection projects, and other water features.

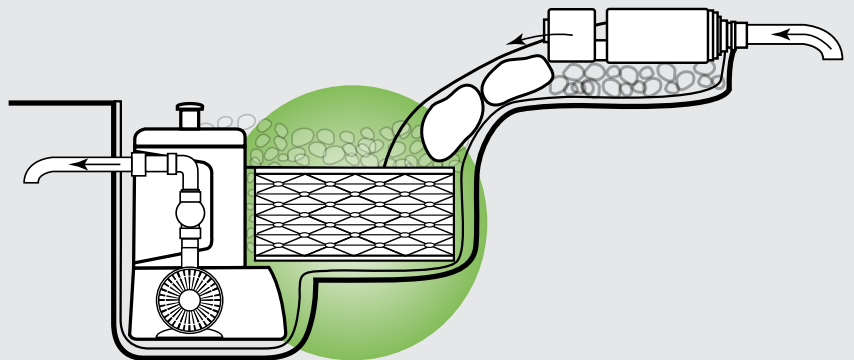

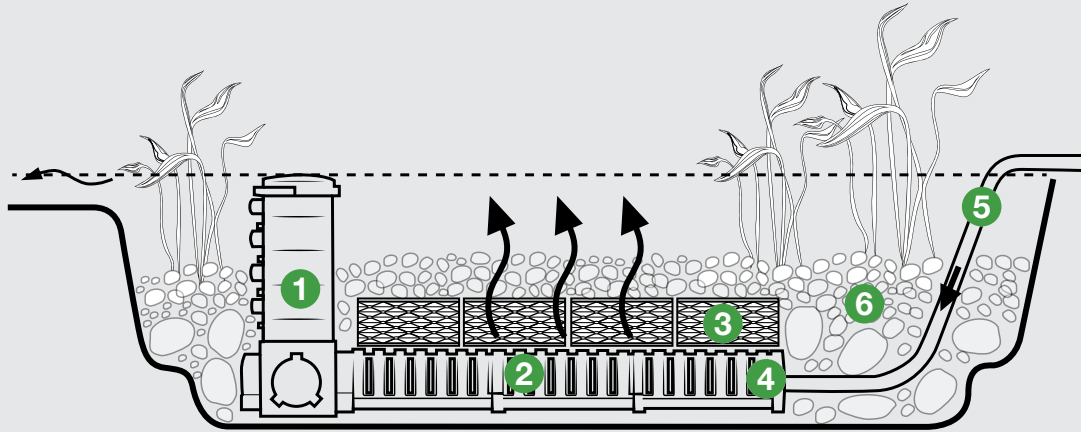

Features

- 1 Snorkel® Vault**
Provides an easy way to remove captured sediment from wetland filters. Simply drop in a cleanout pump to quickly clean the system.
- 2 Large Centipede® Module**
Sits at the lowest point to ensure maximum water distribution and allows for efficient sediment removal during cleaning
- 3 AquaBlox®**
Provides water storage
- 4 Rubber Coupling**
Creates a water-tight seal
- 5 Flex PVC Piping**
Directs water to Centipede Module
- 6 Rocks and Gravel**
Provides valuable filtrations while naturalizing the wetland area

[▶ Click here for Constructed Wetland Filter System Requirements](#)



Large Snorkel® Vault and Cap



Large Snorkel® Vault Extension

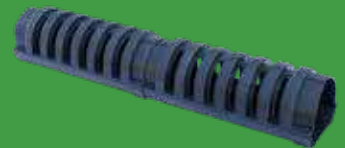

Large Centipede® Module

Item Number	29064	29068	29065
MSRP	\$869.99	\$363.99	\$569.99
Packaged Weight	27 lb.	10 lb.	29 lb.

IonGen™ System G2

Control Panel

Use to adjust ionization levels and indicates when probe is exhausted



Electrical Connections

Quick-connects simplifies installation



Flow Chamber

Positions probe at an angle to prevent clogging and optimize results



#95012 IonGen™ System G2

Packaged Weight: 5 lb.

Packaged Dimensions: 18"L x 4.5"W x 14"H

MSRP: \$569.98

Option 1: Probe can be installed directly into the water feature plumbing

Option 2: Probe can be placed in an area with good water circulation or connected to the check valve using the included probe holder

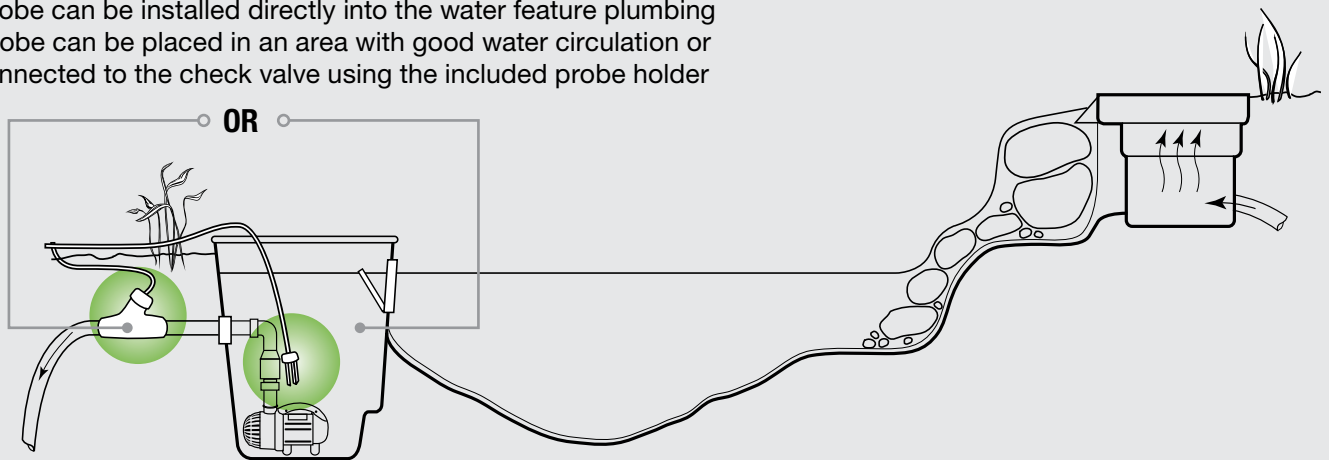

SAY GOODBYE TO Unsightly Debris!

The following accessories and test kits can be used in conjunction with the IonGen™ System.



#95016 IonGen™ Probe for the G2 System

- For 2nd generation flow chamber
- Includes 5 foot quick-connect cable

Packaged Weight: .5 lb.
Packaged Dimensions: 3"L x 2"W x 6"H

MSRP: \$207.98



#95077 IonGen™ G2 Probe Holder

- Allows for installation of G2 Probe without flow chamber
- Can be used in a filter, such as a skimmer or a Pondless® Waterfall Vault
- Straps onto any pipe or check valve from 1-4 inches in diameter

Packaged Weight: 1.5 lb.

MSRP: \$25.98



#96020 Copper Test Kit

- Measures residual copper
- 25 tests per kit

Packaged Weight: .2 lb.
Packaged Dimensions: 4"L x 1.5"W x 5"H

MSRP: \$38.98



#96019 KH/Alkalinity Test Kit

- Measures KH/alkalinity
- 60 tests per kit

Packaged Weight: .2 lb.
Packaged Dimensions: 4"L x 1.5"W x 5"H

MSRP: \$38.98

Pond, Waterfall, and Fountain Pumps

Pumps are the heart of any water feature, circulating water and providing aeration to help create a stable ecosystem.







Control The Flow of Your Waterfall

With an Aquascape Adjustable Flow Pump

Turn up the pump speed for a more voluminous “party-style” waterfall, or dial it down for a quieter, more relaxing waterfall. Options include AquaSurge®, SLD, and AquaForce®.



AquaSurge®



SLD



AquaForce®

Smart Control Receiver

Adjustable flow pumps include the Aquascape Smart Control Receiver to provide on-board flow control adjustment and the option to connect pumps to the Aquascape Smart Control App.



Features

- 1 WiFi Pairing Light
- 2 Integrated Control Panel
- 3 Flow Adjustment Controls
- 4 On/Off Controls
- 5 Hang Tag
- 6 Injection-Molded Housing

Smart Control App

With built-in WiFi connectivity you can control pumps from anywhere using your smartphone or tablet!

Connecting to the App provides a variety of wireless control functions, including flow adjustment, customized scheduling, and the ability to monitor your energy usage.

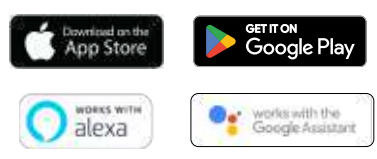

How to Choose a Pond Pump

Did you know our website can walk you through the process of finding the right pump for your water feature?

[▶ Click here to go through the automated steps to find the perfect pump for every situation.](#)

STEP 1

Calculate Your Pump Requirements

Find your recommended flow rate and water feature type

The screenshot shows a web form with the following fields: 'Pond Dimensions' (Length in Feet, Width in Feet, Avg Depth in Feet), 'Waterfall Width' (Width in Inches), 'Head Height' (Elevation in Feet, Pipe Length in Feet, Pipe Diameter), and a 'Calculate' button at the bottom.

Confirm Your Water Feature Type
Pond or Pondless Waterfall?

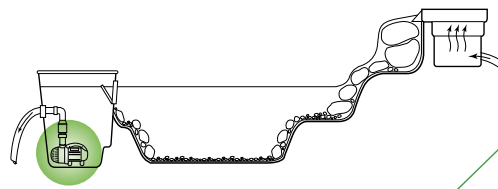

Pond

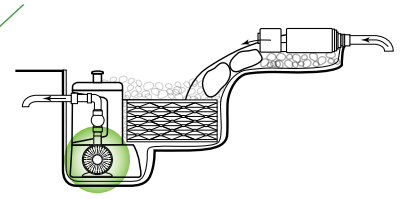

Pondless®

STEP 2

Choose Your Pump Location

For use in a pond skimmer, Pondless Waterfall Vault, or directly in the pond.

Pond Pumps

For Use in Pond Skimmers or Pondless® Waterfall Vault

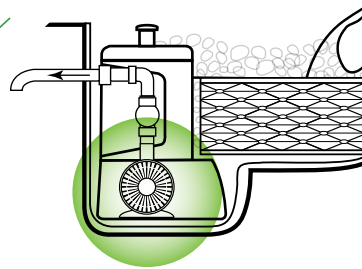
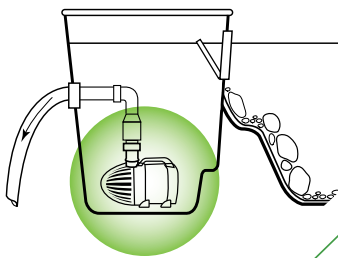

In-Pond Pumps

For Use Directly in the Pond

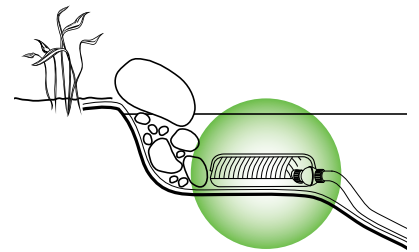

STEP 3

Choose Your Pump Model

Select a pump model that best suits your needs!



Low Maintenance,
Solids-Handling Pumps



Energy-Efficient Pumps



In-Pond Pumps

AquaSurge® Pond Pump

Locking Knob

Allows for quick and easy cage removal

Smart Control Receiver

Provides on-board flow control adjustment and connects to the Aquascape Smart Control App

(For use with the adjustable flow pump models only)



Ceramic Shaft

Unique ceramic shaft and cooling port prevent pump from overheating



Asynchronous Motor

Makes this pump more powerful and more efficient than traditional pond pumps

AquaSurge® 5000 Pond Pump Shown



Universal Remote for Adjustable Flow Pumps

- For use with adjustable flow pumps only

Packaged Weight: .3 lb.

Packaged Dimensions: 5"L x 2.75"W x 1.25"H

MSRP: \$44.99

#45041



Low Suction Intake Attachment

- Not compatible with AquaSurge 4000-8000

Packaged Weight: .5 lb.

Packaged Dimensions: 5.75"L x 4.5"W x 5.75"H

MSRP: \$36.98

#91117



Adjustable Flow Pump Extension Cord

- Extend pumps 25' from the receiver
- For use with adjustable flow pumps only

Packaged Weight: 2 lb.

Packaged Dimensions: 14"L x 4.25"W x 4.25"H

MSRP: \$97.99

#45048

Aquascape AquaSurge asynchronous pumps are designed for use in skimmer and waterfall-filter systems.

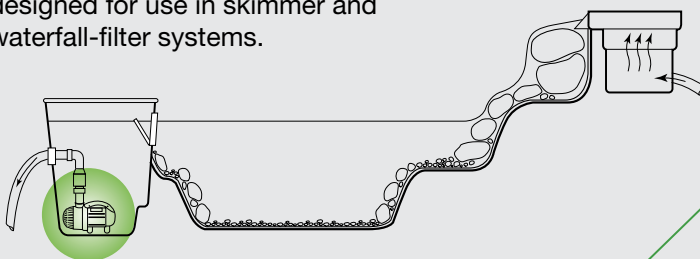

Pond

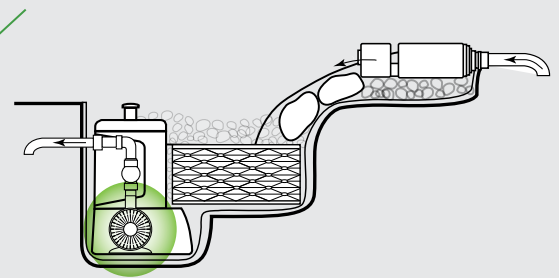

Pondless® Waterfall

AquaSurge® Pond Pump

P

Compare AquaSurge® and AquaSurge® Adjustable Flow Pond Pump Models

	2000	3000	4000	5000	2000-4000 Adjustable Flow	4000-8000 Adjustable Flow
Item Number	91017	91018	91019	91020	45009	45010
MSRP	\$509.98	\$609.98	\$679.98	\$759.98	\$969.99	\$1,169.99
Maximum Flow Rate	2,193 GPH 8,000 LPH	3,196 GPH 12,000 LPH	3,947 GPH 14,500 LPH	5,284 GPH 20,000 LPH	3,947 GPH 14,500 LPH	7,793 GPH 29,500 LPH
Adjustable Flow	—				✓	
Maximum Head Height	12.5'	15'	18.5'	24'	18.5'	28'
Motor Type	Asynchronous					
Wattage	160	165	215	360	180 to 215	500 to 660
Amperage	1.3	1.4	1.82	3	1.82	5.5
Power Cord Length	20'					
Pump Discharge Diameter	1.5" MPT					
Ideal Pipe Diameter	1.5" or 2"					2" or 3"
App/WiFi Connected	—				✓	
Pump Dimensions	12"L x 5.5"W x 7"H		14"L x 6"W x 7.5"H			
Warranty	3-Year Limited					
Packaged Weight	10 lb.	10.25 lb.	12.75 lb.	14 lb.	13 lb.	16 lb.
Packaged Dimensions	13.25"L x 9"W x 9"H	13.25"L x 9"W x 9.75"H	15"L x 9.25"W x 10.5"H	15"L x 9.25"W x 11.25"H	15"L x 9.5"W x 10.5"H	15"L x 9.5"W x 12"H

AquaSurge and AquaSurge Adjustable Flow Pond Pump Flow Chart (GPH)

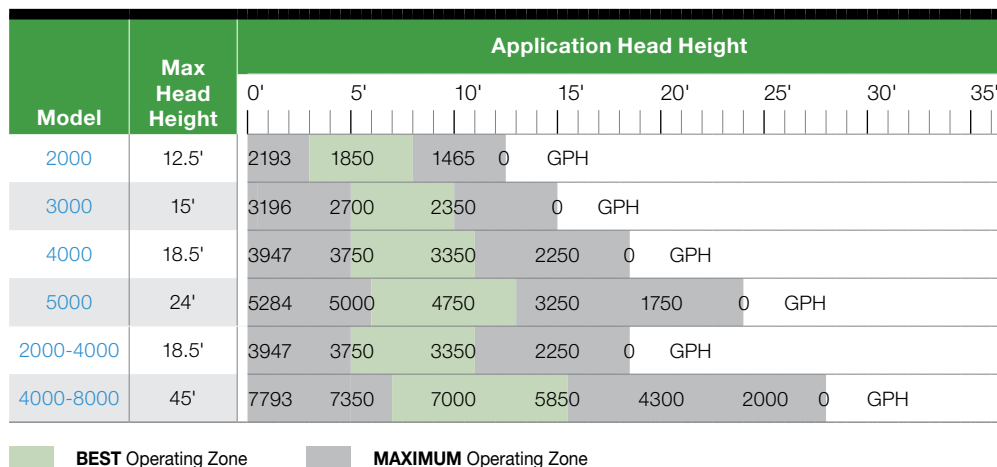

SLD Adjustable Flow Pond Pump

Solids-Handling Capability

Allows the pump to pass solids, significantly reducing clogging and maintenance

2" Outlet

Allows for quick easy installation



Smart Control Receiver

Connects to the Smart Control App, allowing you to control the pump with your smartphone or tablet

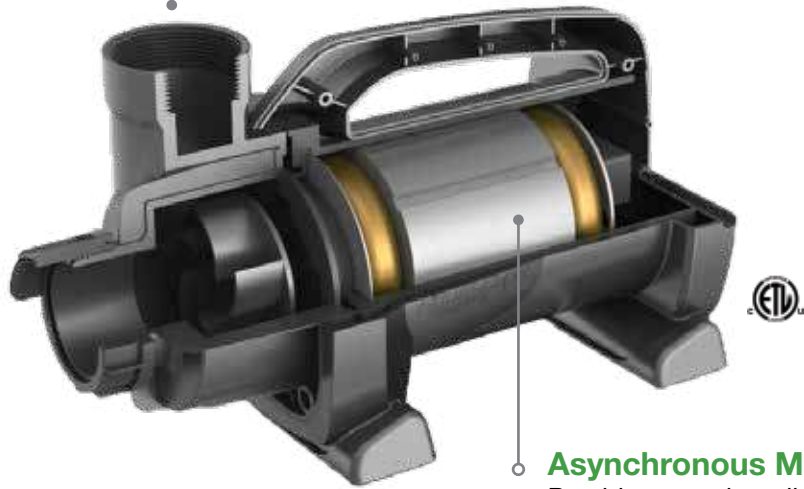

Asynchronous Motor

Provides superior reliability and longevity

SLD 4000-7000 Adjustable Flow Pond Pump Shown

Universal Remote for Adjustable Flow Pumps

- For use with adjustable flow pumps only

Packaged Weight: .3 lb.
Packaged Dimensions: 5"L x 2.75"W x 1.25"H

MSRP: \$44.99

#45041



Adjustable Flow Pump Extension Cord

- Extend pumps 25' from the receiver
- For use with adjustable flow pumps only

Packaged Weight: 2 lb.
Packaged Dimensions: 14"L x 4.25"W x 4.25"H

MSRP: \$97.99

#45048



Aquascape SLD Adjustable Flow Pond Pumps are ideal for use in ponds, Pondless® Waterfalls, and other water feature applications

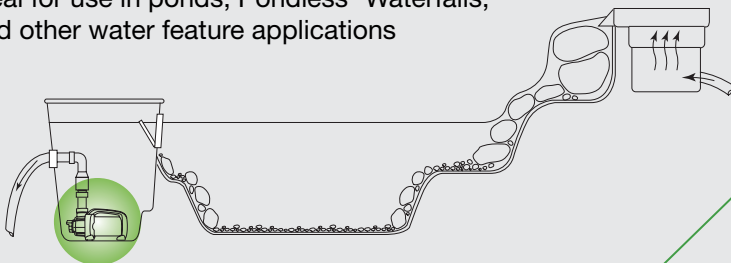

Pond

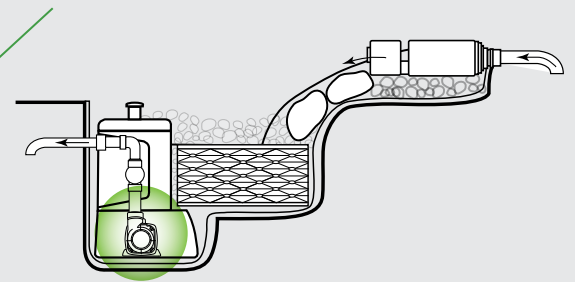

Pondless® Waterfall Vault

SLD Adjustable Flow Pond Pump

P

Compare SLD Adjustable Flow Pond Pump Models

	2000-5000	4000-7000	5000-9000
Item Number	45046	45036	45037
MSRP	\$999.99	\$1,059.99	\$1,299.99
Maximum Flow Rate	6,613 GPH / 25,033 LPH	7,127 GPH / 26,500 LPH	9,574 GPH / 36,000 LPH
Adjustable Flow	✓		
Maximum Head Height	16.7'	25'	33'
Motor Type	Asynchronous		
Wattage	235 to 375	480 to 650	655 to 1005
Amperage	2.81	6.6	8.9
Power Cord Length	20'		
Pump Discharge Diameter	2" FPT		
Ideal Pipe Diameter	2" or 3"		
App/WIFI Connected	✓		
Pump Dimensions	13"L x 6.25"W x 7"H		
Warranty	3-Year Limited		
Packaged Weight	14.5 lb.	17.6 lb.	18.75 lb.
Packaged Dimensions	15"L x 11.5"W x 9.5"H	15.25"L x 12"W x 9.5"H	15.25"L x 12"W x 10.75"H

SLD Adjustable Flow Pond Pump Flow Chart (GPH)

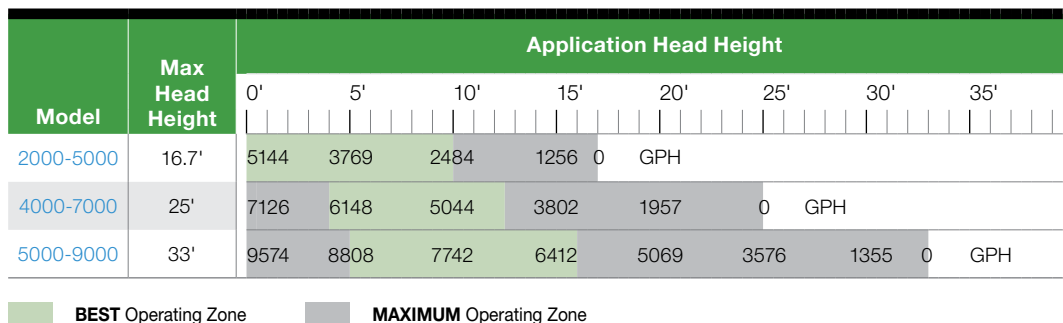

PL and PN Solids-Handling Pond Pump

Overload Protection

Built in thermal overload protection prevents pump from overheating

Shielded Intake

Prevents air from entering pump when used in shallow water applications

Unmatched Dependability

Double mechanical silicone carbide seals and oil lifter provide unmatched dependability



5-PL 5000 Solids-Handling Pond Pump Shown

High Efficiency

Continuous duty motor operates at lower temperature which extends pump life

Reinforced Power Cord

Anti-wicking, water tight design improves durability and prevents issues with electrical shorting

High Volume Flow

Channel impeller and specially designed volute allows for efficient, high volume water flow



12-PN 10000 Solids-Handling Pond Pump Shown

PL and PN Solids-Handling Pond Pump

Compare Aquascape PL and PN Solids-Handling Pond Pump Models

	3-PL	5-PL	9-PL	8-PN	12-PN
Item Number	29975	29976	29977	29495	30391
MSRP	\$869.99	\$1,169.99	\$1,389.99	\$1,179.99	\$1,494.99
Maximum Flow Rate	3,300 GPH / 11,000 LPH	5,300 GPH / 20,000 LPH	7,300 GPH / 27,500 LPH	5,548 GPH / 21,000 LPH	10,000 GPH / 37,500 LPH
Maximum Head Height	14'	23'	35'	56'	23'
Motor Type	Direct Drive				
Wattage	320	620	1000		900
Amperage	3.1	5.6	8.6	9.1	
Power Cord Length	20'				
Pump Discharge Diameter	2"				3"
Ideal Pipe Diameter	1.5" or 2"	2" or 3"			3"
Pump Dimensions	12.2"L x 5.6"W x 7.1"H	13.2"L x 5.9"W x 7.3"H	14"L x 5.9"W x 7.3"H	9.3"L x 6.4"W x 15"H	11.7"L x 7.7"W x 15.1"H
Warranty	2-Year Limited				
Packaged Weight	16 lb.	19 lb.	23 lb.	24 lb.	36 lb.
Packaged Dimensions	13"L x 9.75"W x 9.5"H	15"L x 9.75"W x 9.5"H	15"L x 9.75"W x 9.5"H	17.25"L x 10.25"W x 9"H	12.5"L x 9"W x 17.75"H

Aquascape PL & PN Series Pump Flow Chart (GPH)

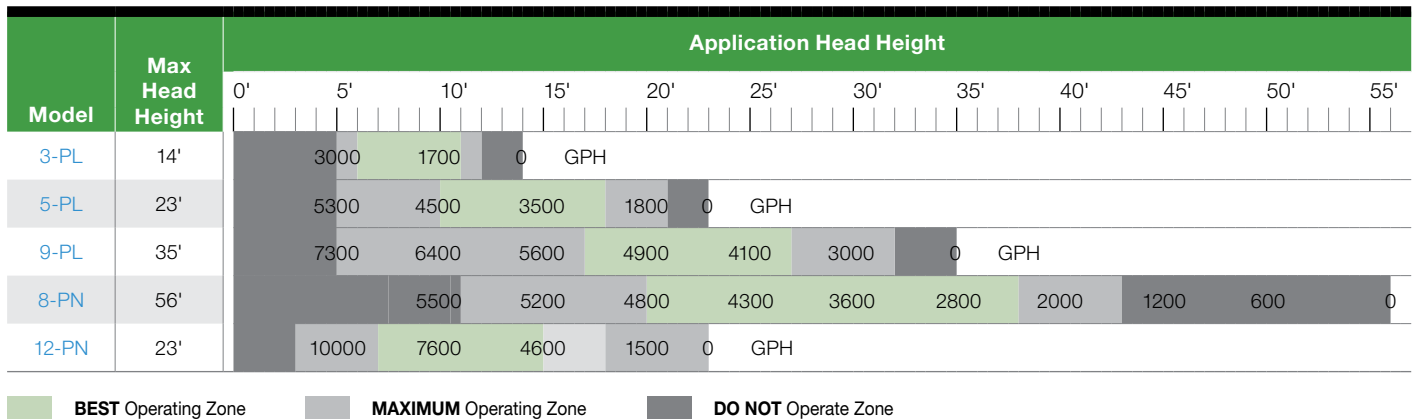

EXT Pond Pump

External/In-Line Pump

Ideal for water features requiring high flow in a non-submersible application

TEFC

Totally enclosed fan-cooled motor



Customized Electrical

Junction box located on pump motor allows 115V or 230V electric to be customized on site

EXT 18000 Pond Pump Shown

EXT Pump 2"-3" Plumbing Kit

- Includes fittings, flanges, valves, and hardware to install the EXT pump at the perimeter of the pond's edge.

Packaged Weight: 21 lb.

Packaged Dimensions: 12.5"L x 12.5"W x 12"H

MSRP: \$909.99

#48027

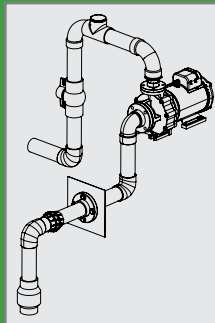

EXT Pump 3" Plumbing Kit

- Includes fittings, flanges, valves, and hardware to install the EXT pump at the perimeter of the pond's edge.

Packaged Weight: 25 lb.

Packaged Dimensions: 12.5"L x 12.5"W x 12"H

MSRP: \$1,039.99

#48044

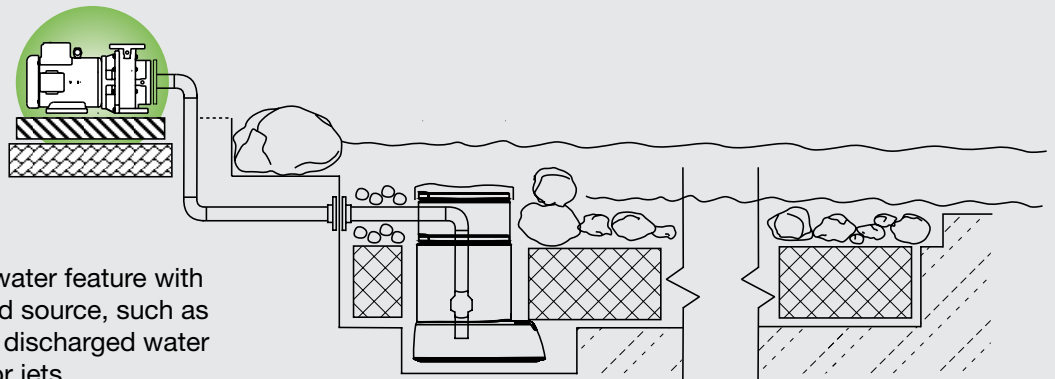

EXT pumps are installed near the water feature with the intake pulling from a pre-filtered source, such as a Pondless Waterfall Vault and the discharged water sent to wetland filters, waterfalls, or jets.

Compare EXT Pond Pump Models

	12000	12000-3P	18000	18000-3P
Item Number	45049	45051	45050	45052
MSRP	\$3,639.99	\$4,939.99	\$4,809.99	\$5,069.99
Maximum Flow Rate	12,500 GPH / 47,318 LPH		18,400 GPH / 69,652 LPH	
Maximum Head Height	21'		45'	
Motor Type/HP	143JM / 3/4 hp	143JM / 1 HP	184JM / 3 HP	
Wattage	1,100	736	3,300	1,932
Maximum Current Amps @	115V - 10 A / 230V - 5 A	230V - 3.2 A / 460V - 1.6 A	115V - 30 A / 230V - 15 A	230V - 8.4 A / 460V - 4.2 A
Power Cord Length	10 ft	-		
Pump Discharge Diameter	2"			
Pump Inlet Diameter	3"			
Ideal Pipe Diameter	3"			
Phase	Single	3-Phase	Single	3-Phase
Pump Dimensions	19.3"L x 11.9"W x 11.75"H		21.15"L x 12.9"W x 11.75"H	21.9"L x 12.65" W x 11.75"H
Warranty	5-Year Limited			
Packaged Weight	114 lb.	115 lb.	114 lb.	115 lb.
Packaged Dimensions	30"L x 17.5"W x 18"H			

EXT Pond Pump Flow Chart (GPH)

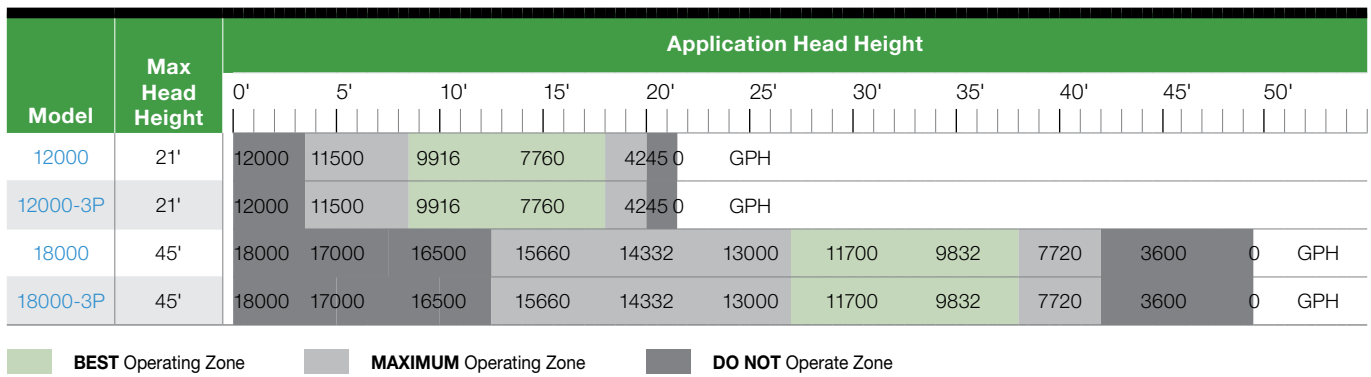

EcoWave® Pond Pump

3-Year Warranty

Confidence in the advantages of today's technology and reliable construction

Overload Sensor

Built-in overload sensor prevents pump damage



Intelligent Mag-Drive Motor

Provides significant electrical cost savings



EcoWave® 4000 Pond Pump Shown



Low Suction Intake Attachment

- Allows pumps to be operated in shallow applications such as the AquaBasin® 45.
- Compatible with the EcoWave® 2000 & 3000.

Packaged Weight: .5 lb.
Packaged Dimensions: 5.75"L x 4.5"W x 5.75"H

MSRP: \$36.98

#91117

Note: Not compatible with EcoWave Pump models 4000 and 5000



Check Valve Adapter for EcoWave Pond Pump - 2"

- Designed to make it quick and easy to connect EcoWave® pumps to the Dual Union Check Valve 2.0 (#48026).

Packaged Weight: .5 lb.
Packaged Dimensions: 3.75"L x 3.75"W x 4"H

MSRP: \$13.98

#88058

Note: Compatible with EcoWave Pump models 2000-5000

EcoWave pond pumps are ideal for use in pond skimmer and Pondless® Waterfall Vault applications with lower head heights.

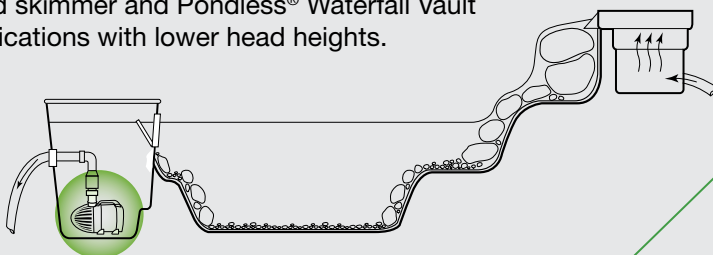

Pond

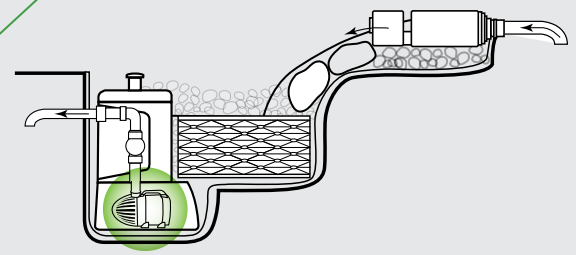

Pondless® Waterfall

Compare EcoWave® Pond Pump Models

	2000	3000	4000	5000
Item Number	91131	91132	91133	91134
MSRP	\$419.98	\$479.98	\$619.98	\$749.98
Maximum Flow Rate	2,020 GPH / 7,500 LPH	2,960 GPH / 11,000 LPH	4,000 GPH / 15,000 LPH	5,000 GPH / 18,500 LPH
Maximum Head Height	14.4'	17.5'	20'	21'
Motor Type	Mag-Drive			
Wattage	65	90	130	150
Amperage	0.54	.75	1.08	1.25
Power Cord Length	20'			
Pump Discharge Diameter	2" MPT			
Ideal Pipe Diameter	1.5" - 2"			2"
Pump Dimensions	11"L x 5.75"W x 7.5"H			
Warranty	3-Year Limited			
Packaged Weight	10.25 lb.	11.5 lb.	13 lb.	14 lb.
Packaged Dimensions	13"L x 11"W x 10.5"H	13"L x 11"W x 11.75"H	13"L x 11"W x 13"H	13"L x 11"W x 14"H

EcoWave® Pond Pump Flow Chart (GPH)

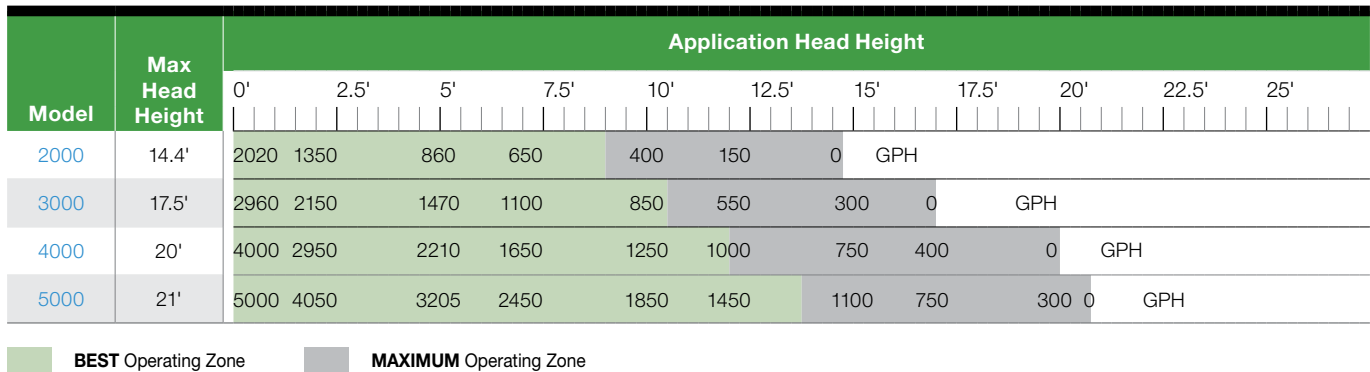

P AquaForce® Solids-Handling Pond Pump

Protective Cage

Prevents large debris from clogging or damaging pump, reducing maintenance

Powerful and Efficient Motor

Asynchronous motor technology makes this pump more powerful and more efficient than traditional “mag-drive,” or magnetically driven pond pumps

Smart Control Receiver

Connects to the Smart Control App, allowing you to control the pump with your smartphone or tablet

(For use with the AquaForce Adjustable Flow Solids-Handling Pond Pump only)



Threaded Disconnect

Allows for the pump to be easily removed from the pond for maintenance or winterization without removing hose clamps or plumbing assembly

AquaForce 4000-8000 Adjustable Flow Solids-Handling Pond Pump Shown



Universal Remote for Adjustable Flow Pumps

- For use with adjustable flow pumps only

Packaged Weight: .3 lb.

Packaged Dimensions: 5"L x 2.75"W x 1.25"H

MSRP: \$44.99

#45041



Adjustable Flow Pump Extension Cord

- Extend pumps 25' from the receiver
- For use with adjustable flow pumps only

Packaged Weight: 2 lb.

Packaged Dimensions: 14"L x 4.25"W x 4.25"H

MSRP: \$97.99

#45048

The AquaForce® protective pre-filter cage allows the pump to be placed directly into the pond.

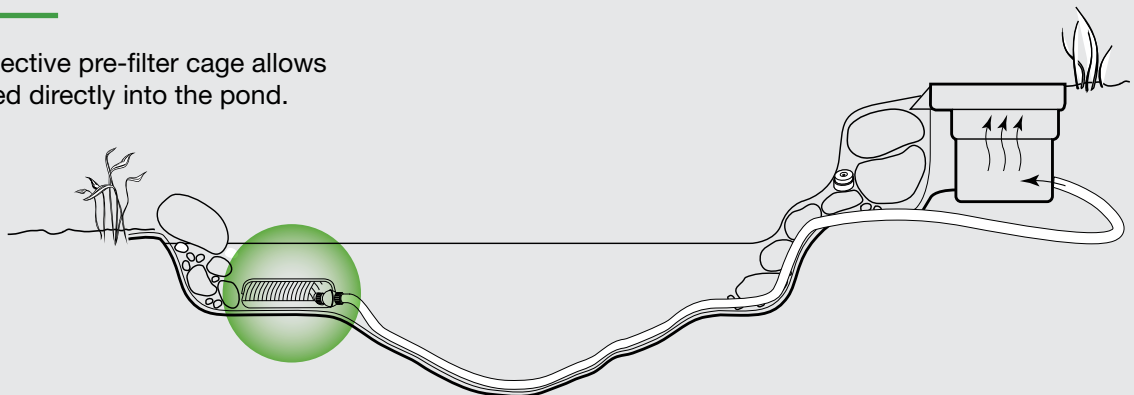

AquaForce® Solids-Handling Pond Pump



Compare AquaForce® Solids-Handling and AquaForce® Adjustable Flow Solids-Handling Pond Pump Models

	1000	1800	2700	3600	5200	Adjustable Flow 4000-8000
Item Number	91011	91112	91012	91113	91013	91104
MSRP	\$329.98	\$399.98	\$419.98	\$489.98	\$619.98	\$1,199.99
Maximum Flow Rate	1,070 GPH 4,000 LPH	2,149 GPH 8,000 LPH	2,695 GPH 10,000 LPH	3,868 GPH 14,500 LPH	5,284 GPH 20,000 LPH	7,793 GPH 29,500 LPH
Adjustable Flow	—					✓
Maximum Head Height	10'	16.5'	14'	18'	24'	28'
Motor Type	Asynchronous					
Wattage	55	160	147	215	360	500 to 660*
Amperage	0.51	1.33	1.25	1.8	3	5.5
Power Cord Length	25'					20'
Pump Discharge Diameter	1.5" MPT					
Ideal Pipe Diameter	1" – 1.5"		1.5" – 2"		2"	2" – 3"
App/WIFI Connected	—					✓
Pump Dimensions	14"L x 14"W x 6.5"H					
Warranty	3-Year Limited					
Packaged Weight	11 lb.	12.25 lb.	12 lb.	14.5 lb.		18.5 lb.
Packaged Dimensions	14.25"L x 14.25"W x 9"H	14.25"L x 15.25"W x 9"H	14.25"L x 15.75"W x 9"H	14.25"L x 16.25"W x 9"H	14.25"L x 16.75"W x 9"H	14.25"L x 18.75"W x 9"H

*Wattage range depending on flow setting

AquaForce Pond Pump Flow Chart (GPH)

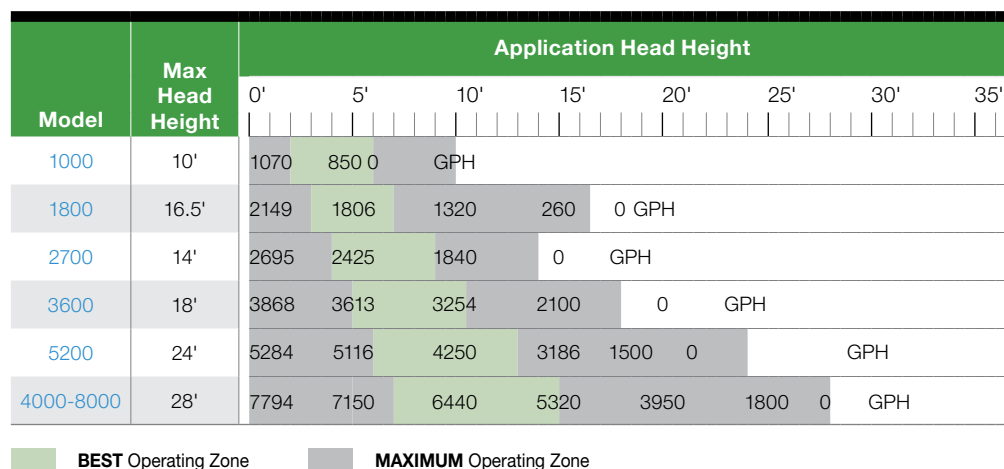

AquaJet® Pond Pump

Diverter and Flow Control

Allows water to be used for fountainhead, circulation, and additional equipment like spitters or external filters and waterfalls

Adjustable Height

The adjustable riser stem allows for easy height adjustment from 10 to 20 inches

Pump Cage Clips

Makes it easy to open to perform pump maintenance or remove debris



AquaJet® 1300 Pond Pump Shown

Add a New Dimension to Your Pond

Each AquaJet pump comes complete with riser stems, multi-hose fitting, diverter valve, and three fountain heads, including foaming jet, daisy and waterbell



Foaming Jet



Daisy



Waterbell

The AquaJet protective pre-filter cage allows the pump to be placed directly into the pond.

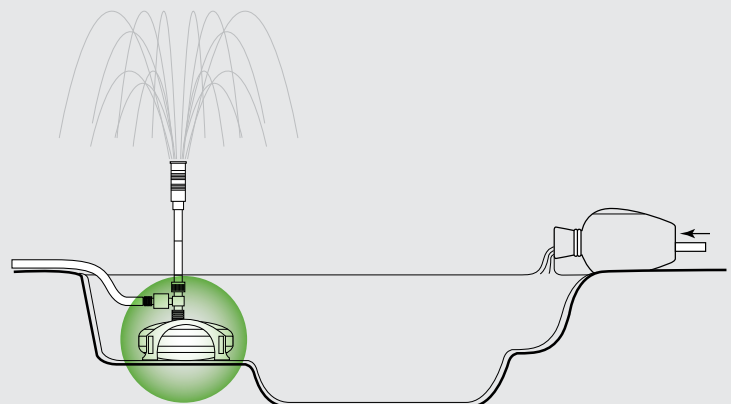

Compare AquaJet® Pond Pump Models

	600	1300	2000
Item Number	91014	91015	91016
MSRP	\$349.98	\$389.98	\$519.98
Pond Size Recommendation	1,200 gal.	1,300 gal.	2,000 gal.
Maximum Fountain Height (Daisy Fountain)	Up to 47"	Up to 62"	Up to 65"
Motor Type	Mag-Drive		
Wattage	33	110	250
Amperage	0.55	1.00	2.60
Power Cord Length	25'		
Pump Discharge Diameter on Diverter	1/2", 3/4"		1/2", 3/4", 1"
Pump Dimensions	12"L x 12"W x 6"H		
Warranty	3-Year Limited		
Packaged Weight	6.5 lb.	9 lb.	9.5 lb.
Packaged Dimensions	13"L x 9"W x 14"H	13.25"L x 8.75"W x 15"H	13.25"L x 9"W x 15.75"H

AquaJet® Pond Pump Flow Chart (GPH)

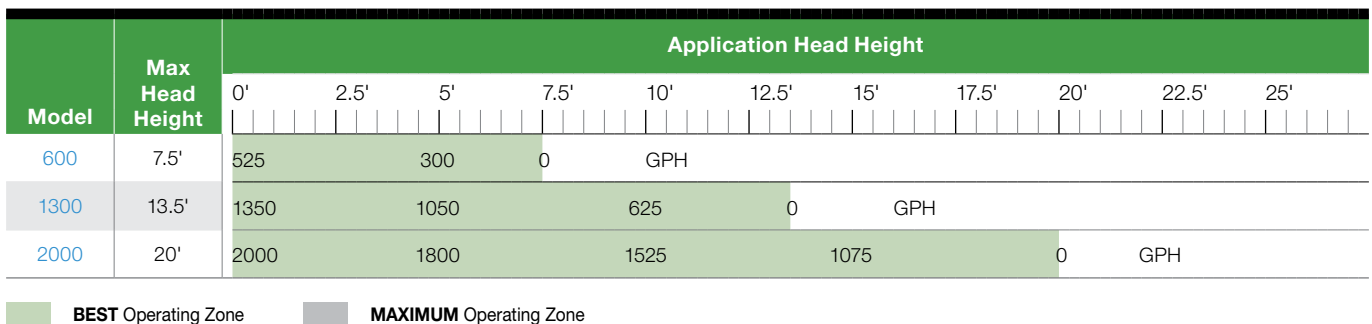

Pond Powerhead

Propeller

Designed to provide water movement in stagnant areas of the pond

Standalone Pump

Does not require any pipe or plumbing

Adjustable Head

Allows for directional flow control



Pond Powerhead Shown



Requires Low-Voltage Transformer
Minimum 60W low voltage transformer required (Sold Separately)

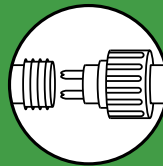

Compatible with Aquascape Quick-Connect Splitters and Extension Cables [See page 89](#)

Typical Application

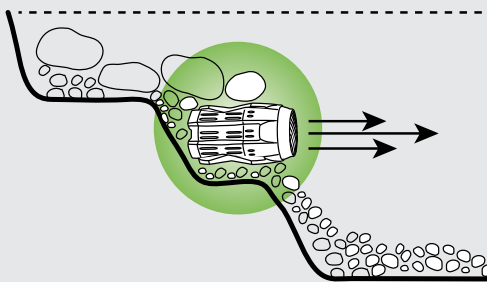

The Aquascape Pond Powerhead is designed to create water movement and eliminate stagnant areas in ponds and water gardens.

Winter Application

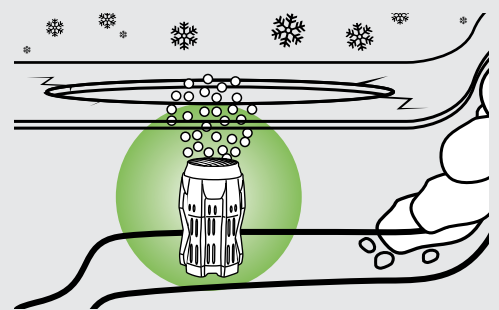

Stand on end and create surface agitation in the winter months helping to keep a hole in the ice for proper gas exchange.

Pond Powerhead

Item Number	91142
MSRP	\$249.98
Maximum Flow Rate	2,000 GPH / 7,647 LPH
Motor Type	Mag-Drive
Wattage	40
Amperage	3.33
Voltage	12V
Frequency	60 Hz
Power Cord Length	25'
Pump Dimensions	9"L x 5.5"W x 5.25"H
Warranty	3-Year Limited
Packaged Weight	9.5 lb.
Packaged Dimensions	13.25"L x 9"W x 15.75"H

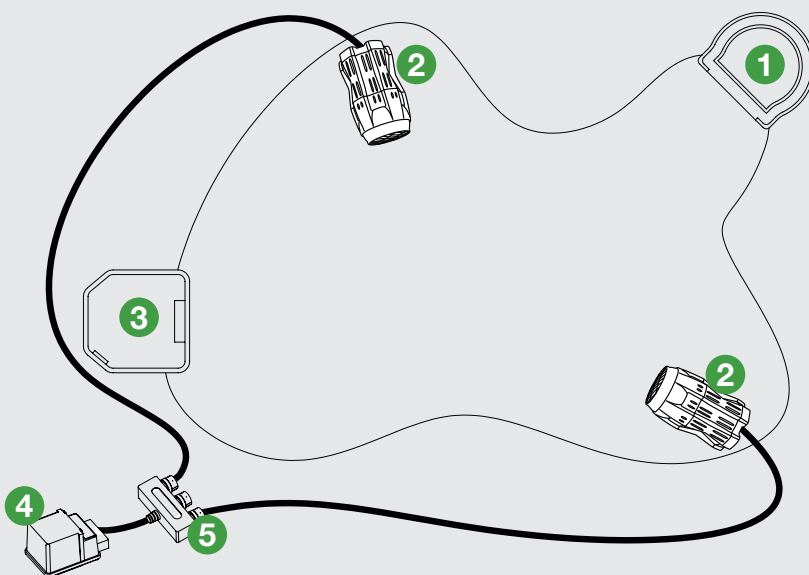

Wiring Diagram

- 1 BioFalls
- 2 Pond Powerhead
- 3 Skimmer
- 4 12-Volt Transformer
- 5 3-Way Quick-Connect Splitter

Ultra Water Pump



Locking Knob
Convenient for quick and easy cage removal

Mag-Drive Motor
Makes this pump energy efficient and simple to maintain



Fittings included with 400/550/800



Fittings included with 1100/1500/2000



Stable
The wide, flat base and rubber feet make the pump stable and reduces vibration

Ultra 1100 Water Pump Shown



Small Ultra Pump Fountain Head Kit

Packaged Weight: .5 lb.
Packaged Dimensions: 5.5"L x 3.5"W x 7.25"H

MSRP: \$25.98 **#91045**

Ideal for Ultra 400, 550, and 800



Large Ultra Pump Fountain Head Kit

Packaged Weight: .5 lb.
Packaged Dimensions: 6"L x 3"W x 9"H

MSRP: \$36.98 **#91046**

Ideal for Ultra 1100, 1500, and 2000

Included fittings integrate seamlessly into Aquascape AquaBasins



Compare Ultra Water Pump Models

	400	550	800	1100	1500	2000
Item Number	91005	91006	91007	91008	91009	91010
MSRP	\$129.98	\$155.98	\$194.98	\$272.98	\$324.98	\$376.98
Maximum Flow Rate	370 GPH 1,000 LPH	528 GPH 1,500 LPH	793 GPH 3,000 LPH	1,110 GPH 4,000 LPH	1,480 GPH 5,500 LPH	1,982 GPH 7,500 LPH
Maximum Head Height	7.5'	8'	9'	12'	16.5'	20'
Motor Type	Mag-Drive					
Wattage	24	33	58	92	153	250
Amperage	0.40	0.55	0.80	0.85	1.46	2.60
Power Cord Length	12'			25'		
Pump Discharge Diameter	1/2", 3/4", 1", and 1.25"					
Ideal Pipe Diameter	1/2" – 1"			3/4" – 1.25"		
Pump Dimensions	5.5"L x 4"W x 3.5"H	6"L x 4"W x 4"H		9"L x 5"W x 6"H	9.5"L x 6"W x 7"H	
Warranty	3-Year Limited					
Packaged Weight	2.5 lb.	3 lb.	4.5 lb.	5.25 lb.	8 lb.	9 lb.
Packaged Dimensions	9"L x 5"W x 5"H	9"L x 5.25"W x 5.25"H	9"L x 6.5"W x 6"H	9.5"L x 6.75"W x 7"H	10.5"L x 8"W x 8"H	10.5"L x 8"W x 9"H

Ultra Water Pump Flow Chart (GPH)

Model	Max Head Height	Application Head Height									
		0'	2.5'	5'	7.5'	10'	12.5'	15'	17.5'	20'	22.5'
400	7.5'	370	300	200	0	GPH					
550	8'	528	425	300	75	0	GPH				
800	9'	793	675	500	275	0	GPH				
1100	12'	1110	1000	800	600	300	0	GPH			
1500	16.5'	1480	1350	1200	1050	825	575	200	0	GPH	
2000	20'	1985	1875	1750	1600	1375	1125	800	450	0	GPH

BEST Operating Zone MAXIMUM Operating Zone

Statuary Water Pump

Mag-Drive Motor

Makes this pump energy efficient and simple to maintain

Flow Control

Allows you to create a customized water flow



Intake Strainer

Prevents the pump from running dry or pulling in air in shallow applications

90 GPH Water Pump Shown

Compare Statuary Water Pump Models

	70	90	180	320
Item Number	91023	91024	91025	91026
MSRP	\$24.98	\$29.98	\$44.98	\$59.98
Maximum Flow Rate	70 GPH / 250 LPH	90 GPH / 300 LPH	180 GPH / 650 LPH	320 GPH / 1,200 LPH
Maximum Head Height	2'	3'	4'	5.5'
Motor Type	Mag-Drive			
Wattage	3.0	4.3	9.3	17.6
Amperage	.037	.061	.175	.339
Power Cord Length	6'			
Pump Discharge Diameter	1/2", 5/8"			
Pump Dimensions	2"L x 1.5"W x 1.25"H	2.5"L x 1.75"W x 2"H	3"L x 2.5"W x 2"H	4"L x 3.25"W x 2.5"H
Warranty	3-Year Limited			
Packaged Weight	.75 lb.		1.25 lb.	2 lb.
Packaged Dimensions	4"L x 4"W x 2.75"H	4.25"L x 4"W x 3.25"H	4"L x 4"W x 4"H	4"L x 4"W x 4.75"H



Pump Cleaner Maintenance Solution



Cleanout Pump



Cleanout Pump Discharge Hose 50'

Item Number	91143	45033	48019
MSRP	\$29.98	\$1,039.99	\$181.99
Packaged Weight	.75 lb.	26 lb.	14.75 lb.
Packaged Dimensions	8 oz. bottle	10"L x 8.25"W x 14"H	22.5"L x 22.5"W x 9"H

The Aquascape Pump Cleaner Maintenance Solution (#91143) uses cutting-edge cleaning compounds to remove scale and biofilm to restore the pump.

Before



After



Pond Aerators

Adding pond aeration can help improve water conditions and optimize fish health.





A 2-Outlet and 4-Outlet Pond Aeration Kits

Quiet Operation

Rubber feet and internal gasket prevents noise and vibration

Durability

Strong outer housing protects the pump from becoming damaged



Weighted Aeration Discs

Provide ideal air flow for ponds and water gardens

4-Outlet Pond Aeration Kit Shown



Pond Aerator Aeration Disc

Packaged Weight: .5 lb.

Packaged Dimensions: 5"L x 9"W x 1"H

MSRP: \$16.98

#75005

Heat and excess debris can cause low oxygen levels in your pond. Adding an Aquascape pond aerator will help ensure your pond is oxygenated properly, creating a healthy and safe environment for your fish.

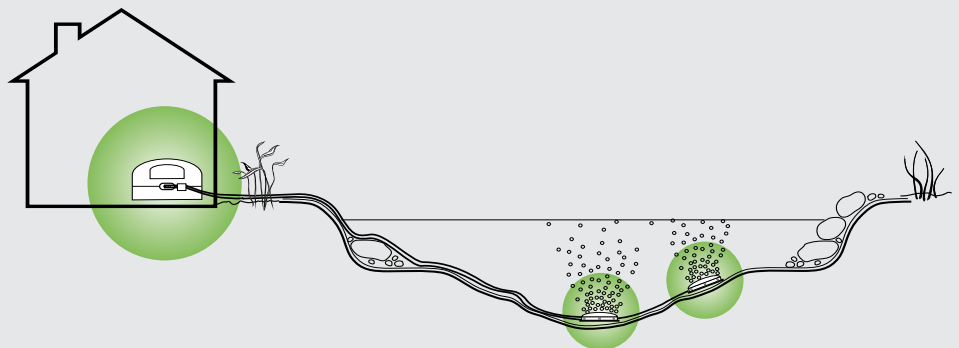

2-Outlet and 4-Outlet Pond Aeration Kits

A

Compare 2 and 4-Outlet Pond Aeration Kits

	2-Outlet Pond Aeration Kit	4-Outlet Pond Aeration Kit
Item Number	75000	75001
MSRP	\$103.98	\$175.98
Pond Size	Up to 2,000 gal.	Up to 3,500 gal.
Maximum Recommended Pond Depth	8.5'	9'
Maximum Air Flow Rate (Loaded)	0.28 CFM (8 L/min)	0.49 CFM (14 L/min)
Maximum Air Depth (Loaded)	3.70 psi (0.26 kgf/cm ²)	3.98 psi (0.28 kgf/cm ²)
Number of Aeration Discs	2	4
Wattage	6	11
Check Valve	Included and pre-installed	
Power Cord Length	6'	
Length of Airline	(2) 25' rolls 3/16" silicone	(4) 25' rolls 3/16" silicone
Pump Dimensions	5.25"L x 4.75"W x 3.5"H	7.75"L x 7.25"W x 6.25"H
Warranty	3-Year Limited	
Packaged Weight	3.5 lb.	6.25 lb.
Packaged Dimensions	15.5"L x 4"W x 12"H	17.75"L x 5.5"W x 11.75"H



Understanding Aeration

Every biological process that occurs in ponds is dependent on oxygen. This is especially important in warmer temperatures or at night when plants are not converting sunlight into oxygen. Pond aerators supply dissolved oxygen directly to ponds and other water features, helping all biological processes and resulting in healthier fish and plants.

Pro Air Pond Aeration Kits

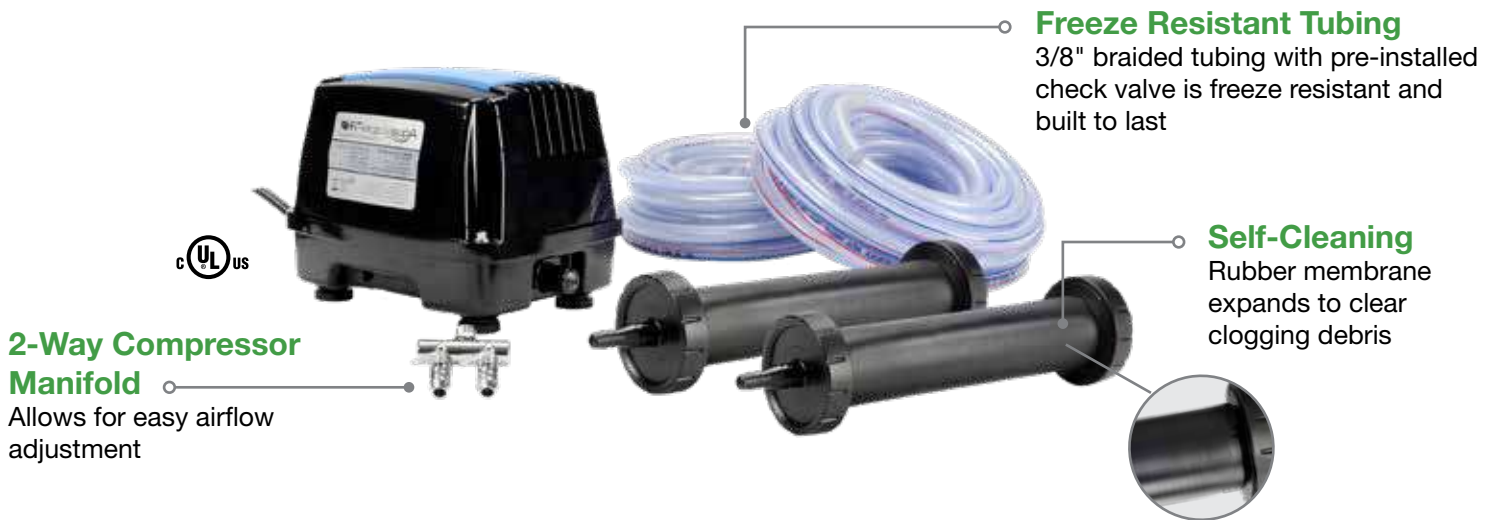

Pro Air 60 Pond Aeration Kit Shown

Compare Pro Air Pond Aeration Kits

	Pro Air 20	Pro Air 60
Item Number	61009	61008
MSRP	\$259.99	\$509.99
Pond Size	Up to 5,000 gal.	Up to 15,000 gal.
Maximum Recommended Pond Depth	6.5'	11.5'
Maximum Air Flow Rate (Loaded)	0.71 CFM (20 L/min)	2.1 CFM (60 L/min)
Maximum Air Depth (Loaded)	2.90 psi (0.20 kgf/cm ²)	5.08 psi (0.36 kgf/cm ²)
Number of Outlets	1	2 (Includes 2-Way Manifold)
Number of Diffusers	1	2
Wattage	15	45
Check Valve	Included and pre-installed	
Power Cord Length	6'	
Airline Length	(1) 30' Roll 3/8" Braided Vinyl	(2) 30' Roll 3/8" Braided Vinyl
Pump Dimensions	6"L x 5.5"W x 4.25"H	7.75"L x 7.25"W x 6.25"H
Aeration Diffuser Dimensions	10"L x 4"H	
Warranty	3-Year Limited	
Packaged Weight	11.5 lb.	22 lb.
Packaged Dimensions	12"L x 11"W x 10"H	14.25"L x 12.75"W x 9"H

Pro Air Pond Aeration Accessories

A



Pro Air 20 Aeration Compressor



Pro Air 60 Aeration Compressor

Item Number	61017	61016
MSRP	\$194.99	\$376.99
Pond Size	Up to 5,000 gal.	Up to 15,000 gal.
Maximum Recommended Pond Depth	6.5'	11.5'
Maximum Air Flow Rate (Loaded)	0.71 CFM (20 L/min)	2.1 CFM (60 L/min)
Maximum Air Depth (Loaded)	2.90 psi (0.20 kgf/cm ²)	5.08 psi (0.36 kgf/cm ²)
Number of Outlets	1	2
Wattage	15	45
Power Cord Length	6'	
Dimensions	6"L x 5.5"W x 4.25"H	7.75"L x 7.25"W x 4"H
Aeration Diffuser	Sold Separately	
Length of Airline	Sold Separately	
Check Valve	Sold Separately	
Warranty	3-Year Limited	
Packaged Weight	5.7.5 lb.	11.5 lb.
Packaged Dimensions	8.75"L x 7.5"W x 7"H	9.5"L x 7.75"W x 8.25"H



Seasonal Care

The aeration compressor can be used during winter months, when bubbles and water movement created at the surface help to maintain a small opening in the ice for oxygenation.

Pro Air Pond Aeration Accessories



Weighted Aeration Tubing
3/8" x 25'



Weighted Aeration Tubing
3/8" x 100'



10" Rubber Membrane
Aeration Diffuser

Item Number	61011	61014	61010
MSRP	\$64.99	\$219.99	\$55.99
Packaged Weight	7.3 lb.	32 lb.	2.75 lb.
Packaged Dimensions	13"L x 13"W x 4.75"H	18"L x 14"W x 9"H	11.75"L x 4"W x 4"H

Pro Air Pond Aeration Accessories

A



2-Way Aeration
Compressor Manifold



Pond Aerator
Pro Check Valve



Barbed Coupling 3/8"

Item Number	61012	61003	99159
MSRP	\$20.99	\$12.99	\$7.99
Packaged Weight	.25 lb.	.2 lb.	.25 lb.

Pond and Landscape Lighting

The complete line of Aquascape LED pond lights and garden lighting makes it easy to enjoy your water feature or garden at night!





Color-Changing Lights



Color-changing lights require a Smart Control Hub and 12V transformer



Smart Control Hub

Packaged Weight: .75 lb.
Packaged Dimensions: 4.75"L x 2"W x 4.75"H

MSRP: \$199.98

#84074



12V Quick-Connect Transformers

[See page 94](#)



Color-Changing Light Remote

Allows wireless control without the use of a smartphone or tablet

MSRP: \$54.98

#84073

Simple and Easy to Connect to Existing Lighting Systems

Run Separately or Connect to Existing Low-Voltage Lights

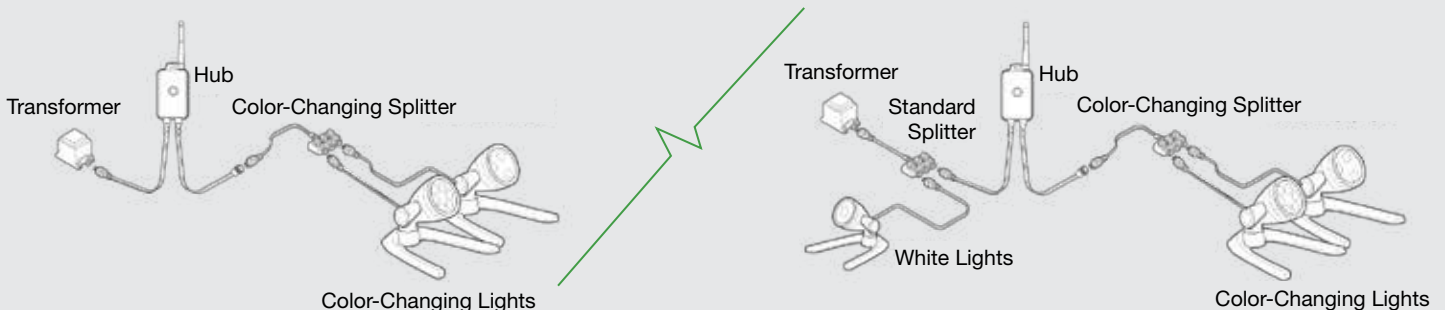

Color-Changing Lights

L

Compare LED Color-Changing Lights



2-Watt
Color-Changing
Waterfall Light

4.5-Watt
Color-Changing
Spotlight

8-Watt
Color-Changing
Spotlight

Item Number	84057	84059	84060
MSRP	\$179.98	\$309.98	\$379.98
Lumens	52 lm / White	128 lm / White	223 lm / White
Wattage	2W±10%	4.5W±10%	8W±10%
Voltage Min-Max	10.8V – 15V		
Temperature in Kelvin	3,000 K		
Color Rendering Index (CRI)	70 / White		
Beam Angle Spread	30°		
Bulb Life	40,000 Hours		
12V Quick-Connect Fitting	✓		
Fixture Material	Die-Cast Metal		
Smart Control Hub #84074 Required (Sold Separately)	✓		
Cord Length	15'		
Light Dimensions	2" Diameter x 1.5"H	3" Diameter x 3"H	
Warranty	5-Year Limited		
Packaged Weight	1.25 lb.	2.75 lb.	
Packaged Dimensions	4.75"L x 4.5"W x 7.5"H	5.25"L x 5.25"W x 13.25"H	6.25"L x 6.25"W x 16.25"H

Color-Changing Fountain Lights



Color-Changing Fountain Light

Color-Changing Fountain Light Kit

Note: All in one kit, not WiFi compatible

Item Number	84072	84055
MSRP	\$99.98	\$179.98
Lumens	20 lm / White	
Wattage	2W±10%	
Voltage Min-Max	10.8V – 15V	
Temperature in Kelvin	3,000 K	
Color Rendering Index (CRI)	70 / White	
Beam Angle Spread	30°	
Bulb Life	40,000 Hours	
Fixture Material	Plastic	
Includes Required Transformer	–	✓
Smart Control Hub #84074 Required (Sold Separately)	✓	Not compatible
Cord Length	15'	
Light Dimensions	1.5 in Diameter x 2.5 in H	
Acceptable Pipe Diameter	1/2" – 3/4"	
Packaged Weight	0.5 lb.	2.25 lb.
Packaged Dimensions	3.75"L x 1.75"W x 8.25"H	5.5"L x 2.75"W x 7.75"H

K | F | P | A | L | PWR | WT | PC | SC | FC | APC | D | LUG | PP | IT | RH

Color-Changing Light Extension Cables

L



25'
Color-Changing
Light Extension
Cable



25' 5-Outlet
Color-Changing
Light Extension
Cable



3-Way
Color-Changing
Light Splitter



6-Way
Color-Changing
Light Splitter

Item Number	84069	84070	84062	84068
MSRP	\$59.98	\$89.98	\$51.98	\$99.98
Quick-Connect Connections	1	5	3	6
Type of Quick-Connect	4-Prong			
Cord Length	25'		6"	12"
Packaged Weight	1.25 lb.	1.5 lb.	.25 lb.	.75 lb.
Packaged Dimensions	7.25"L x 1.75"W x 5.75"H	7"L x 2.5"W x 6.25"H	4"L x 1.5"W x 3"H	7.25"L x 1.75"W x 2"H

Color-Changing Light Extension Cables

The Aquascape color-changing lighting extension cables allow for simple extension of Aquascape color-changing lighting. They are ideal for use with our 12-volt quick-connect transformers and 3-way and 6-way splitters. The 12-volt quick-connect components eliminate the need to cut wires and provide a weatherproof seal. Not compatible with Aquascape LED white lights.

Color-Changing Light Splitters

Aquascape color-changing splitters provide a simple connection of 3 or 6 color-changing fixtures to a single power source. Multiple 3-way and 6-way splitters can be chained together to attach additional fixtures. Not compatible with Aquascape LED white lights.

3-Light Spotlight Kit



3-Light Spotlight Kit Shown

3-Light Spotlight Kit Includes



- Three pre-wired 1-watt LED lighting fixtures



- Adjustable stands and landscape stakes



- 6-watt / 12 V transformer



- Pond and Landscape Quick-Connect Photocell with Timer

3-Light Spotlight Kit

Item Number	84030
MSRP	\$239.98
Lumens	140
Wattage	3
Temperature in Kelvin	3,000 K
Bulb Life	40,000 Hours
Cord Length	15'
Warranty	5-Year Limited
Packaged Weight	4 lb.
Packaged Dimensions	16.5"L x 3.5"W x 12"H

Wiring Diagram

- ① (3) 1-Watt LED Spotlights (included)
- ② Quick-Connect Photocell (included)
- ③ 6-Watt Low Voltage Quick-Connect Transformer (included)

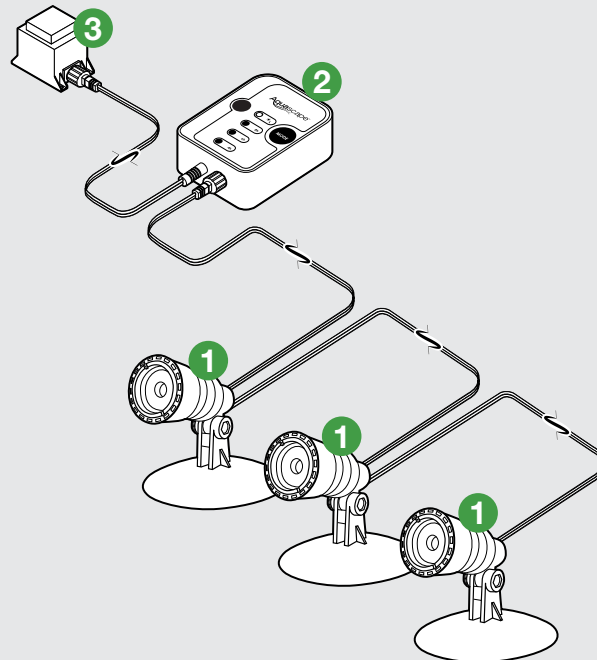

Warm White Lights



Wiring Diagram

- 1 6-Watt Spotlight
- 2 3-Watt Spotlight
- 3 1-Watt Spotlight
- 4 1-Watt Waterfall Light
- 5 3-Way Quick-Connect Splitter (not included)
- 6 6-Way Quick-Connect Splitter (not included)
- 7 25' Quick-Connect Extension Cable (not included)
- 8 Photocell with Digital Timer (not included)
- 9 12-Volt Transformer (required, not included)

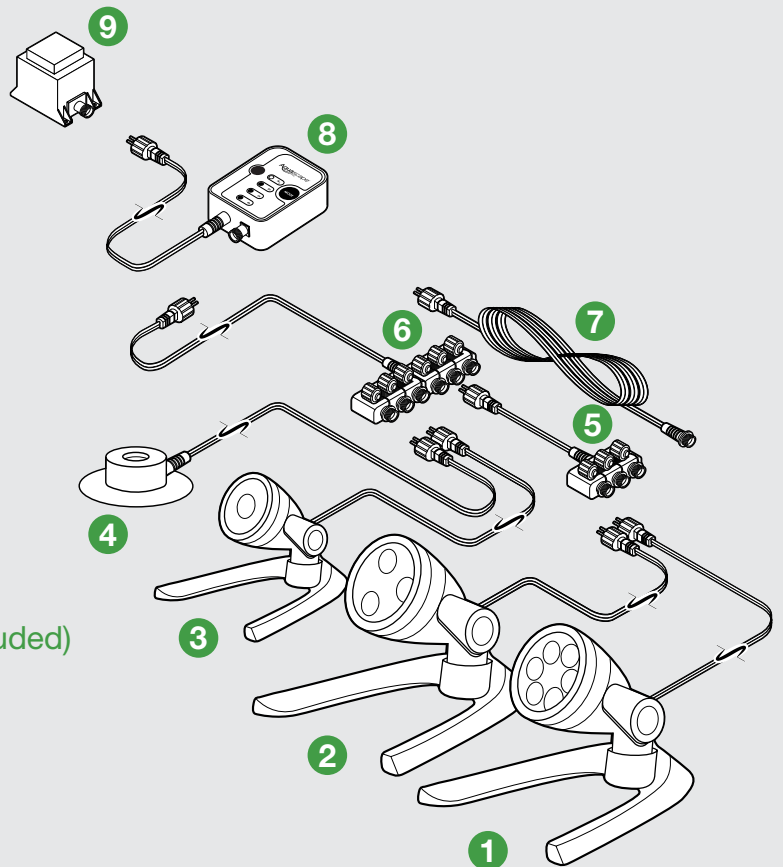

Warm White Lights

L

Compare Pond and Landscape LED Lights



Note: All Pond and Landscape Lights require 12V transformer

1-Watt Waterfall Light

1-Watt Spotlight

3-Watt Spotlight

6-Watt Spotlight

Item Number	84032	84031	84033	84034
MSRP	\$89.98	\$89.98	\$199.98	\$249.98
Lumens	45 lm		150 lm	340 lm
Wattage	1.2W±10%		3W±10%	5.8W±10%
Voltage Min-Max	9V – 15V			
Temperature in Kelvin	3,000 K			
Color Rendering Index (CRI)	75			
Beam Angle Spread	30°			
Bulb Life	40,000 Hours			
Fixture Material	Die-Cast Metal			
Cord Length	14.5'			
Light Dimensions	2" Diameter x 1.5"H	1.25" Diameter x 2"H	3" Diameter x 3"H	
Warranty	5-Year Limited			
Packaged Weight	1 lb.		2.5 lb.	2.75 lb.
Packaged Dimensions	4.75"L x 4.5"W x 7.5"H	4.75"L x 3.75"W x 11"H	5"L x 5"W x 13"H	6.25"L x 6"W x 14"H

Available in a 6-Pack!



- 1-Watt Waterfall Light 6-Pack
MSRP: \$479.98 [#84046](#)
- 1-Watt Spotlight 6-Pack
MSRP: \$479.98 [#84045](#)
- 3-Watt Spotlight 6-Pack
MSRP: \$1,059.98 [#84047](#)
- 6-Watt Spotlight 6-Pack
MSRP: \$1,349.98 [#84048](#)

K | F | P | A | L | PWR | WT | PC | SC | FC | APC | D | LUG | PP | IT | RH

Warm White Fountain Lights



Note: All Pond and Landscape Lights require 12V transformer

Fountain Light

Fountain Light Kit with Transformer

Item Number	84008	84009
MSRP	\$74.98	\$103.98
Lumens	24 lm	
Wattage	2.5W±10%	
Voltage Min-Max	10.8V – 15V	
Temperature in Kelvin	3,000 K	
Color Rendering Index (CRI)	70	
Beam Angle Spread	30°	
Bulb Life	40,000 Hours	
12V Quick-Connect Fitting	✓	
Fixture Material	Plastic	
Cord Length	15'	
Light Dimensions	1.5" Diameter x 2.5"H	
Acceptable Pipe Diameter	1/2" – 3/4"	
Warranty	5-Year Limited	
Packaged Weight	1 lb.	2 lb.
Packaged Dimensions	2.75"L x 2.5"W x 8.25"H	5.5"L x 2.5"W x 7.25"H



25'
Quick-Connect
Extension Cable



25' 5-Outlet
Quick-Connect
Extension Cable



3-Way
Quick-Connect
Splitter



6-Way
Quick-Connect
Splitter

Item Number	98998	84023	98489	84022
MSRP	\$34.98	\$51.98	\$21.98	\$34.98
Quick-Connect Connections	1	5	3	6
Type of Quick-Connect	2-Prong			
Cord Length	25'		6"	12"
Packaged Weight	1 lb.		.5 lb.	.75 lb.
Packaged Dimensions	5.75"L x 2.75"W x 5.75"H		2.5"L x 1.5"W x 3.75"H	8"L x 8"W x 2"H



Quick-Connect Photocell with Timer

- Can be used to control Aquascape white and color-changing lights
- Auto on at dusk/off at dawn or 4, 6, 8 hour timer option
- Built-in memory setting in case of power loss
- Integrates easily with other 12-volt quick-connect components
- Up to 60-Watt capacity

Packaged Weight: .75 lb.

Packaged Dimensions: 2"L x 1.25"W x 3.25"H with a 36" cord

MSRP: \$51.98

#84039

Path and Area Landscape Lights



Hat Top Path and Area Landscape Light Shown



Path and Area 3-Watt LED Bulb

Energy-efficient 3-Watt LED bulb provides a warm 2700 Kelvin output and a 25,000-hour bulb life span. (Replacement Part)

MSRP: \$29.98

[#84067](#)



Aquascape LED Lights

Each fixture features durable brass construction with an antique bronze finish, providing a long-lasting, professional-quality light that can be enjoyed year after year.

Path and Area Landscape Lights

L

Compare Path and Area Landscape Lights



Hat Top



Dome Top

Note: All Path and Area Landscape Lights require 12V transformer

Item Number	84063	84064
MSRP	\$194.98	\$194.98
Lumens	270 lm	
Wattage	3W±10%	
Voltage Min-Max	9V – 15V	
Temperature in Kelvin	2,700 K	
Color Rendering Index (CRI)	80	
Beam Angle Spread	120°	90°
Bulb Life	25,000 Hours	
Fixture Material	Brass	
Cord Length	3'	
Light Dimensions	6.5" Diameter x 18.25"H	
Warranty	5-Year Limited	
Packaged Weight	1.75 lb.	
Packaged Dimensions	5.75"L x 5.75"W x 9.25"H	



Available in a 6-Pack!



- Hat Top Path and Area Landscape Light 6-Pack
MSRP: \$1,069.98 [#84065](#)
- Dome Top Path and Area Landscape Light 6-Pack
MSRP: \$1,069.98 [#84066](#)

K | F | P | A | L | PWR | WT | PC | SC | FC | APC | D | LUG | PP | IT | RH

Power Accessories

Aquascape offers a variety of power accessories, including an array of low-voltage transformers and a WiFi-enabled Smart Control Plug. Use the transformers to power low-voltage lighting or low-voltage accessories and control them all with the Smart Control Plug using the Smart Control App on your smartphone or tablet.

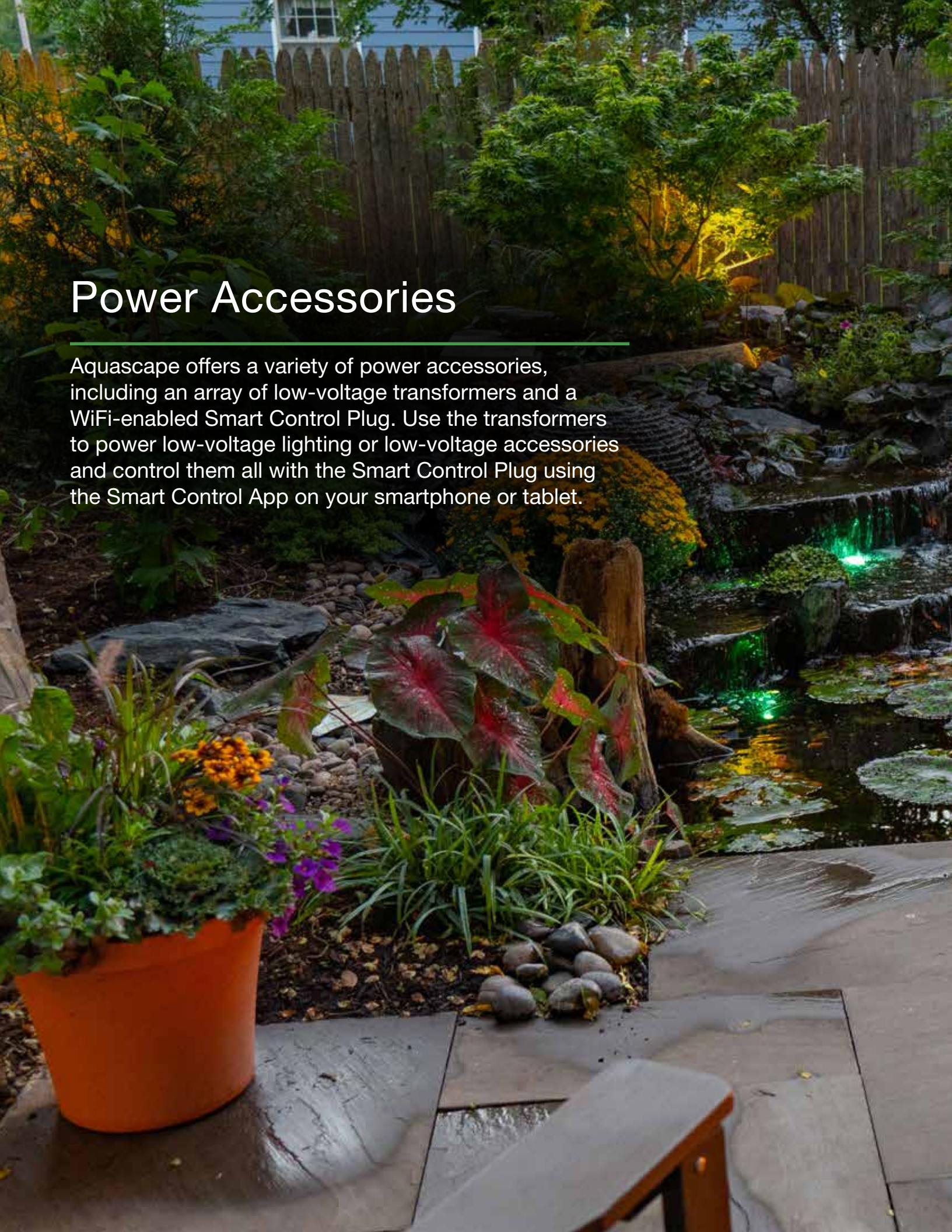





Compare Low Voltage Transformers



Item Number	98375	98485	98486	99070	01002
MSRP	\$50.98	\$77.98	\$103.98	\$149.98	\$233.98
Quick-Connect Connections	1				3
Type of Quick-Connect	2-Prong				
Photocell Included	—			✓	
Transformer Dimensions	3"L x 1.5"W x 2.25"H	4"L x 1.75"W x 2.5"H	3"L x 6"W x 3"H	3.5"L x 7"W x 2.5"H	47"L x 7"W x 3.5"H
Packaged Weight	1 lb.	1.75 lb.	3.5 lb.	4 lb.	8 lb.
Packaged Dimensions	6.5"L x 3"W x 4.5"H	6.25"L x 2"W x 4"H	6"L x 2"W x 4"H	8.75"L x 7.5"W x 4.25"H	7.75"L x 4"W x 4"H

Smart Control Plug

PWR



#82001 Smart Control Plug

Packaged Weight: .5 lb.
Dimensions: 6"L x 1.5"W x 5.5"H with 6" cord
Packaged Dimensions: 7"L x 2"W x 6"H
MSRP: \$89.98

Control Aquascope water features with your smartphone or tablet

Monitor your energy usage on the Aquascope Smart Control App to make informed decisions about your energy consumption.



Water Treatments

Aquascape has a variety of options to clean and maintain your pond, waterfall or fountain. Select from Simple Solutions, Beneficial Bacteria, Problem Solving, Algae Fighting, Water Conditioners, Sludge Fighting, Fountain Treatments, and Lake and Large Pond Treatments.

Simple
Solutions

Beneficial
Bacteria

Sludge
Fighting

Water
Conditioners

Algae
Fighting

Problem
Solving

Fountain

Lake and
Large Pond



Aquascape Simple Solutions Water Treatments Are Designed to Make Your Life Easier!

By combining our best water treatments into four treatments for ponds and two for waterfalls and fountains, we have a solution for the most common water feature issues. Choose a simple pump top or use the dosing system versions and prepare to be amazed at the results.

Simple Solutions Treatments for Ponds



Maintain for Ponds

Staple water treatment for ponds, designed to keep ponds clean and healthy

What It Does

- Reduces maintenance
- Supports a healthy ecosystem
- Provides healthy and crystal-clear water conditions

How It Works

- Combines our most effective water treatments into one powerful formulation (like a multivitamin)
- Uses a beneficial bacteria blend, phosphate binder, flocculant clarifier, and detoxifier

Clear for Ponds

Use to clear unsightly water conditions, including cloudy and discolored water

What It Does

- Clarifies water and resolves water quality problems
- Mitigates cloudy or discolored water and issues with debris attached to rocks and gravel

How It Works

- Uses a concentrated formula of clarifiers and a phosphate binder which work to prevent and eliminate issues with water clarity and debris buildup



Clean for Ponds

Use to naturally reduce organic sludge and debris

What It Does

- Reduces organic waste caused by uneaten fish food, fish waste, and leaves or debris
- Naturally cleans rocks, gravel, and filters
- Keeps ponds looking clean and clear

How It Works

- Uses a powerful blend of heterotrophic bacteria to digest organic waste and sludge

Protect for Ponds

Use to protect pond fish such as koi and goldfish. Great for use after transporting/handling fish or cleanouts.

What It Does

- Reduces fish stress
- Prevents parasites and infections
- Accelerates healing of superficial wounds, scrapes and breeding abrasions

How It Works

- Uses an all-natural formulation of tea tree oil and other plant-based biopolymers

Simple Solutions Treatments for Fountains and Waterfalls



Prevent for Fountains

Staple product for fountains, cleans and clarifies

What It Does

- Controls white-scale buildup, foam, and stains
- Helps to clear unsightly water conditions and debris that attaches to surfaces

How It Works

- Contains a special blend of clarifiers and scale remover that will not damage fountain surface

Note: Not for use with water features containing fish

Clean for Fountains

Used to clear unsightly suspended debris

What It Does

- Keeps waterfalls and fountains clean, clear, and healthy
- Reduces maintenance and improves water quality

How It Works

- Uses a flocculant clarifier and phosphate binder to help clear and prevent debris



NEW

Application Options

Choose between simple pump top options or one of our Automatic Dosing Systems which automatically add treatment, so you don't have to!

SL Dosing System ●

Ideal for Ponds, Waterfalls, and Fountains up to 2,000 Gallons

NEW

Hood Design

Designed to hide and protect mounted control panels from weather conditions

Compact Design

Sleek and compact to easily hide near smaller water features

Durable Housing

Built to last and can be buried to conceal

Easy-to-Use Controller

Simply set for your water feature size and enjoy the benefits



Storage Capacity

Store up to 32 oz. of water treatment



#96085 Dosing System SL

- Treat smaller water features with ease

Includes: enclosure, control panel, treatment intake, internal and external tubing, and low-voltage transformer

Packaged Weight: 3 lb.

Packaged Dimensions: 6"L x 4"W x 10"H

MSRP: \$194.98

Size Comparison with XT

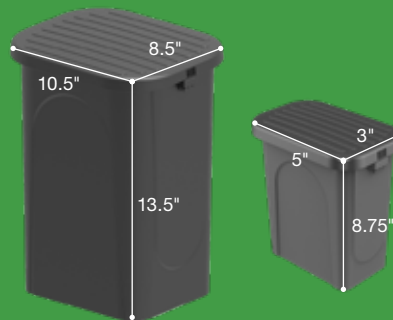

Water Treatments Sold Separately

For more treatment options [see page 101](#)



SL Water Treatments for Ponds and Fountains

Designed only for use with the SL Dosing System

NEW



Maintain
for Ponds

Clear
for Ponds

Clean
for Ponds

Protect
for Ponds

Prevent
for Fountains

Clean
for Fountains

Item Number	96090	96091	96092	96093	96094	96095
MSRP	\$42.98	\$42.98	\$42.98	\$42.98	\$42.98	\$42.98
Package Size	32 oz. / 946 ml					
Packaged Weight	2.5 lb.					
Usage	Refer to page 98				Refer to page 99	

Smart Pond Dosing System XT ●

Ideal for Ponds, Waterfalls, and Fountains up to 75,000 Gallons

Durable Enclosure

Stores up to a gallon of treatment for longer durations between refills



Smart Control

Connect to the app to control, monitor, and receive alerts on your smartphone or tablet

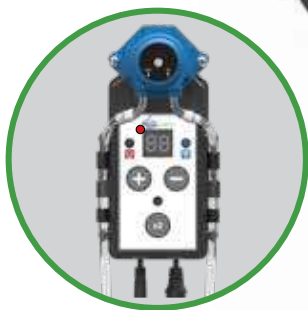

Mounted Controller

Push-button design makes it easy to set for your water feature size



Low-Treatment Alert

Alerts you when the treatment is 90% empty

#40040 Smart Pond Dosing System XT

- Manage treating larger water features with ease

Includes: enclosure, (1) control panel, (1) treatment intake with low treatment alert, internal and external treatment tubing, and low-voltage transformer

Packaged Weight: 6 lb.

Packaged Dimensions: 11.5"L x 9.75"W x 15.25"H

MSRP: \$329.99

Add Two Different Treatments Simultaneously!



Smart Pond Dosing System Controller Add-On Kit

- Add to Smart Pond Dosing System XT to dose two 64 oz. treatments simultaneously
- Includes intake assembly, tubing, and power cable

Packaged Weight: .75 lb.

Packaged Dimensions: 11"L x 4.75"W x 3.75"H

MSRP: \$185.99

#40042



Water Treatments Sold Separately

For more treatment options [see page 103](#)

XT Water Treatments for Ponds and Fountains

Designed only for use with the Smart Pond XT System. [Refer to page 98-99 for usage](#)

Maintain for Ponds

Item Number	40048	40049	40032	40033
MSRP	\$71.99	\$129.99	\$181.99	\$324.99
Concentration	Standard 1X		3X	
Package Size	64 oz. / 1.89 L	1 gal. / 3.78 L	64 oz. / 1.89 L	1 gal. / 3.78 L
Packaged Weight	4.4 lb.	8.7 lb.	4.4 lb.	8.7 lb.



Clear for Ponds

Item Number	40050	40051	40034	40035
MSRP	\$71.99	\$129.99	\$181.99	\$324.99
Concentration	Standard 1X		3X	
Package Size	64 oz. / 1.89 L	1 gal. / 3.78 L	64 oz. / 1.89 L	1 gal. / 3.78 L
Packaged Weight	4.4 lb.	8.7 lb.	4.4 lb.	8.7 lb.



Clean for Ponds

Item Number	40052	40053	40036	40037
MSRP	\$71.99	\$129.99	\$181.99	\$324.99
Concentration	Standard 1X		3X	
Package Size	64 oz. / 1.89 L	1 gal. / 3.78 L	64 oz. / 1.89 L	1 gal. / 3.78 L
Packaged Weight	4.4 lb.	8.7 lb.	4.4 lb.	8.7 lb.



Protect for Ponds

Item Number	40054	40055	40038	40039
MSRP	\$71.99	\$129.99	\$181.99	\$324.99
Concentration	Standard 1X		3X	
Package Size	64 oz. / 1.89 L	1 gal. / 3.78 L	64 oz. / 1.89 L	1 gal. / 3.78 L
Packaged Weight	4.4 lb.	8.7 lb.	4.4 lb.	8.7 lb.



Prevent for Fountains

Item Number	40056	40057	40058	40059
MSRP	\$71.99	\$129.99	\$71.99	\$129.99
Package Size	64 oz. / 1.89 L	1 gal. / 3.78 L	64 oz. / 1.89 L	1 gal. / 3.78 L
Packaged Weight	4.4 lb.	8.7 lb.	4.4 lb.	8.7 lb.

Clean for Fountains



Automatic Dosing System ●

Water Feature Size Indication

Indicates how many gallons of water are contained in the feature



X2 Button

Doubles the dosage for new features, problem features, or after a cleaning



Installation Options

Can be mounted vertically to a post using the included mounting plate or partially buried in the ground

	Automatic Dosing System for Ponds	Automatic Dosing System for Fountains
Item Number	96030	96031
MSRP	\$194.98	\$194.98
Packaged Weight	6 lb.	
Packaged Dimensions	9"L x 8.25"W x 14.5"H	
Free Water Treatment Included	Maintain for Ponds	Prevent for Fountains



Automatic Dosing System Replacement Pump Cartridge

Packaged Weight: .1 lb.

Packaged Dimensions: 3.5"L x 1"W x 1.7"H

MSRP: \$21.98

#96040

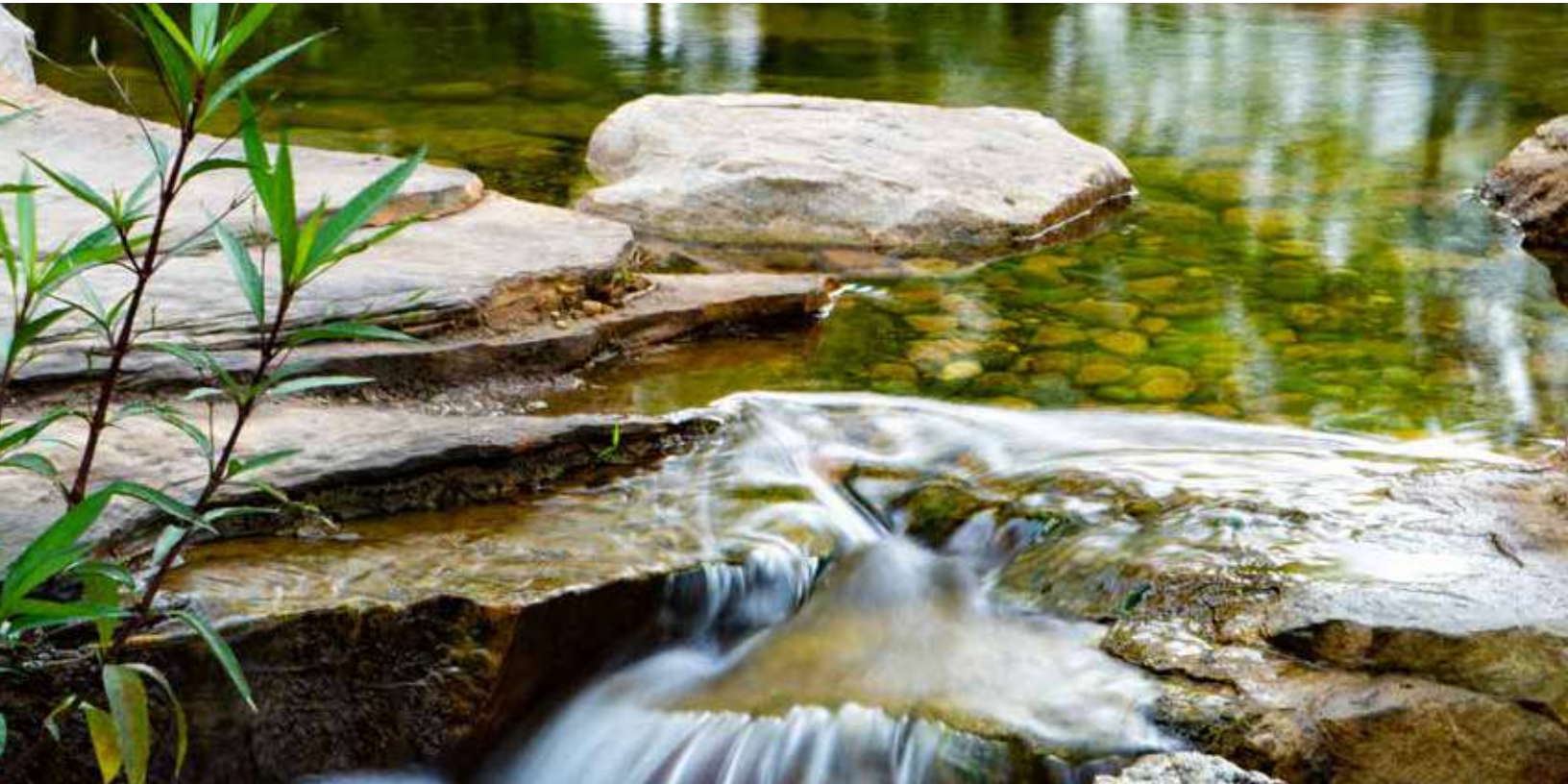

Automatic Dosing System Water Treatments

Designed only for use with the original Automatic Dosing System



Maintain
for Ponds



Clear
for Ponds



Clean
for Ponds



Protect
for Ponds



Prevent
for Fountains



Clean
for Fountains

Item Number	96032	96033	96034	96035	96042	96037
MSRP	\$42.98	\$42.98	\$42.98	\$42.98	\$42.98	\$42.98
Package Size	32 oz. / 946 ml Pouch					
Packaged Weight	2.25 lb.					
Usage	Refer to page 98				Refer to page 99	

Simple Solutions Pump-Top for Ponds

▶ [Click here to learn more about how each treatment works](#)

Maintain for Ponds

Item Number	96057	96058	96059	96060
MSRP	\$19.98	\$25.98	\$42.98	\$104.98
Package Size	8 oz. / 236 ml	16 oz. / 473 ml	32 oz. / 946 ml	1 gal. / 3.78 L
1 Pump Treats	100 gal. / 3.78 L			600 gal. / 2,268 L
1 Bottle Treats	5,000 gal. / 18,900 L	10,000 gal. / 37,800 L	20,000 gal. / 75,600 L	80,000 gal. / 302,400 L
Packaged Weight	.75 lb.	1.25 lb.	2.5 lb.	8 lb.



Clear for Ponds

Item Number	96065	96066	96067	96068
MSRP	\$19.98	\$25.98	\$42.98	\$104.98
Package Size	8 oz. / 236 ml	16 oz. / 473 ml	32 oz. / 946 ml	1 gal. / 3.78 L
1 Pump Treats	100 gal. / 3.78 L			600 gal. / 2,268 L
1 Bottle Treats	5,000 gal. / 18,900 L	10,000 gal. / 37,800 L	20,000 gal. / 75,600 L	80,000 gal. / 302,400 L
Packaged Weight	.75 lb.	1.25 lb.	2.5 lb.	8 lb.



Clean for Ponds

Item Number	96061	96062	96063	96064
MSRP	\$19.98	\$25.98	\$42.98	\$104.98
Package Size	8 oz. / 236 ml	16 oz. / 473 ml	32 oz. / 946 ml	1 gal. / 3.78 L
1 Pump Treats	100 gal. / 3.78 L			600 gal. / 2,268 L
1 Bottle Treats	5,000 gal. / 18,900 L	10,000 gal. / 37,800 L	20,000 gal. / 75,600 L	80,000 gal. / 302,400 L
Packaged Weight	.75 lb.	1.25 lb.	2.5 lb.	8 lb.



Protect for Ponds

Item Number	96069	96070	96071	96072
MSRP	\$19.98	\$25.98	\$42.98	\$104.98
Package Size	8 oz. / 236 ml	16 oz. / 473 ml	32 oz. / 946 ml	1 gal. / 3.78 L
1 Pump Treats	100 gal. / 3.78 L			600 gal. / 2,268 L
1 Bottle Treats	5,000 gal. / 18,900 L	10,000 gal. / 37,800 L	20,000 gal. / 75,600 L	80,000 gal. / 302,400 L
Packaged Weight	.75 lb.	1.25 lb.	2.5 lb.	8 lb.



● Simple Solutions Pump-Top for Fountains

WT



[▶ Click here to learn more about how each treatment works](#)

	Prevent for Fountains			
Item Number	96073	96074	96075	96076
MSRP	\$19.98	\$25.98	\$42.98	\$104.98
Package Size	8 oz. / 236 ml	16 oz. / 473 ml	32 oz. / 946 ml	1 gal. / 3.78 L
1 Pump Treats	100 gal. / 3.78 L			600 gal. / 2,268 L
1 Bottle Treats	5,000 gal. / 18,900 L	10,000 gal. / 37,800 L	20,000 gal. / 75,600 L	80,000 gal. / 302,400 L
Packaged Weight	.75 lb.	1.25 lb.	2.5 lb.	8 lb.



Note: Not for use with water features containing fish

	Clean for Fountains			
Item Number	96077	96078	96079	96080
MSRP	\$19.98	\$25.98	\$42.98	\$104.98
Package Size	8 oz. / 236 ml	16 oz. / 473 ml	32 oz. / 946 ml	1 gal. / 3.78 L
1 Pump Treats	100 gal. / 3.78 L			600 gal. / 2,268 L
1 Bottle Treats	5,000 gal. / 18,900 L	10,000 gal. / 37,800 L	20,000 gal. / 75,600 L	80,000 gal. / 302,400 L
Packaged Weight	.75 lb.	1.25 lb.	2.5 lb.	8 lb.



Beneficial Bacteria ●

▶ [Click here to learn more about how each treatment works](#)

Beneficial Bacteria

- Contains 8 strains of bacteria including photosynthetic strains
- Contains marigold and vitamin B



Item Number	98886	98887	98888	40002	98885
MSRP	\$18.98	\$25.98	\$45.98	\$25.98	\$103.98
Package Size	8 oz. / 236 ml	16 oz. / 473 ml	32 oz. / 946 ml	32 oz. / 946 ml pouch	1 gal. / 3.78 L
1 Pump Treats	100 gal. / 378 L			—	600 gal. / 2,268 L
1 Bottle Treats	5,000 gal. / 18,900 L	10,000 gal. / 37,800 L	20,000 gal. / 75,600 L		80,000 gal. / 302,400 L
Packaged Weight	.75 lb.	1.25 lb.	2.5 lb.	2.25 lb.	8 lb.

Beneficial Bacteria Concentrate

- Contains 8 strains of bacteria including photosynthetic strains
- Contains marigold and vitamin B
- Ideal for larger ponds



Item Number	98925	98948	98949	98950
MSRP	\$19.98	\$28.98	\$45.98	\$194.98
Package Size	4.4 oz. / 125 g	8.8 oz. / 250 g	1.1 lb. / 500 g	7 lb. / 3.2 kg
1 Scoop Treats	1,300 gal. / 4,914 L			
1 Container Treats	26,000 gal. / 98,280 L	52,000 gal. / 196,560 L	104,000 gal. / 393,120 L	660,400 gal. / 2,499,886 L
Packaged Weight	.25 lb.	.75 lb.	1.25 lb.	7.5 lb.

Cold Water Beneficial Bacteria

- Reduces ammonia, nitrite, and organic debris
- Ideal for use in water colder than 50°F (5°C)



Item Number	98892	98893	98894	96021
MSRP	\$19.98	\$32.98	\$51.98	\$129.98
Package Size	8 oz. / 236 ml	16 oz. / 473 ml	32 oz. / 946 ml	1 gal. / 3.78 L
1 Pump Treats	100 gal. / 378 L			600 gal. / 2,268 L
1 Bottle Treats	5,000 gal. / 18,900 L	10,000 gal. / 37,800 L	20,000 gal. / 75,600 L	80,000 gal. / 302,400 L
Packaged Weight	.75 lb.	1.25 lb.	2.5 lb.	8 lb.

▶ [Click here to learn more about how each treatment works](#)

Pond Starter Bacteria

- Quickly establishes biological ecosystem
- Great for spring startups and new ponds
- Safe for fish, plants, and animals



Item Number	96013	96014	96015	96008
MSRP	\$20.98	\$32.98	\$51.98	\$116.98
Package Size	8 oz. / 236 ml	16 oz. / 473 ml	32 oz. / 946 ml	1 gal. / 3.78 L
1 Pump Treats	100 gal. / 378 L			600 gal. / 2,268 L
1 Bottle Treats	5,000 gal. / 18,900 L	10,000 gal. / 37,800 L	20,000 gal. / 75,600 L	80,000 gal. / 302,400 L
Packaged Weight	.75 lb.	1.25 lb.	2.5 lb.	8 lb.

Bacteria Bubble Tabs

- Keeps pond water clean and clear
- Maintains a balanced ecosystem
- Reduces pond maintenance



Item Number	98951	98930
MSRP	\$19.98	\$32.98
Package Size	36 Tabs	72 Tabs
1 Tablet Treats	100 gal. / 378 L	
1 Container Treats	3,600 gal. / 13,608 L	7,200 gal. / 27,216 L
Packaged Weight	.25 lb.	.75 lb.

Sludge Fighting ●

▶ [Click here to learn more about how each treatment works](#)

Pond Sludge Remover Packs

- Eliminates and prevents pond sludge
- Water soluble packs make it easy to spot treat and treat hard-to-reach areas
- Keeps rocks, gravel, and filters clean



Item Number	96081	96084	96082
MSRP	\$25.98	\$42.98	\$77.98
Package Size	18 Packs	36 Packs	72 Packs
1 Pack Treats	1,000 gal. / 3,780 L		
1 Container Treats	18,000 gal. / 68,040 L	36,000 gal. / 120,960 L	72,000 gal. / 272,550 L
Packaged Weight	.5 lb.	1 lb.	2.5 lb.

Sludge & Filter Cleaner

- Biological pond and filter cleaner
- Contains 5 strains of heterotrophic bacteria
- Contains marigold and humic acid
- Safe for fish, plants, and animals



Item Number	98889	98890	98891	98883
MSRP	\$17.98	\$25.98	\$45.98	\$116.98
Package Size	8 oz. / 236 ml	16 oz. / 473 ml	32 oz. / 946 ml	1 gal. / 3.78 L
1 Pump Treats	100 gal. / 378 L			600 gal. / 2,268 L
1 Bottle Treats	5,000 gal. / 18,900 L	10,000 gal. / 37,800 L	20,000 gal. / 75,600 L	80,000 gal. / 302,400 L
Packaged Weight	.75 lb.	1.25 lb.	2.5 lb.	8 lb.

Water Conditioners

WT

▶ [Click here to learn more about how each treatment works](#)

Pond Detoxifier

- Makes tap water safe for fish and plants
- Removes and detoxifies chlorine
- Neutralizes ammonia
- Detoxifies and chelates copper and heavy metal



Item Number	98876	98877	40005	96010
MSRP	\$14.98	\$20.98	\$32.98	\$129.98
Package Size	8 oz. / 236 ml	16 oz. / 473 ml	32 oz. / 946 ml pouch	1 gal. / 3.78 L
1 Pump Treats	100 gal. / 378 L		—	600 gal. / 2,268 L
1 Bottle Treats	5,000 gal. / 18,900 L	10,000 gal. / 37,800 L	20,000 gal. / 75,600 L	80,000 gal. / 302,400 L
Packaged Weight	.75 lb.	1.25 lb.	2.25 lb.	8 lb.

Ammonia Neutralizer

- Neutralizes large concentrations of toxic ammonia
- Makes pond water safe for fish and plants
- Detoxifies chloramine in tap water



Item Number	96050	96051	96052
MSRP	\$28.98	\$50.98	\$114.98
Package Size	16 oz. / 473 ml	32 oz. / 946 ml Pouch	1 gal. / 3.78 L
1 Pump Treats	100 gal. / 378 L		600 gal. / 2,268 L
1 Bottle Treats	10,000 gal. / 37,800 L	20,000 gal. / 75,600 L	80,000 gal. / 302,400 L
Packaged Weight	1.25 lb.	2.25 lb.	8 lb.



#96027 #96028 Alkalinity Booster

- Keeps pond water clean and clear
- Maintains a balanced ecosystem
- Reduces pond maintenance



#80000 Activated Pond Carbon

- Removes discoloration and odors
- Made with bamboo carbon
- Clarifies pond water



#98909 Pond Foam Free

- Safely eliminates foam near waterfalls
- Helps keep water clean and clear of foam
- Safe for fish, animals, and plants

Item Number	96027	96028	80000	98909
MSRP	\$25.98	\$45.98	\$38.98	\$20.98
Package Size	1.1 lb. / 500 g	9 lb. / 4.08 kg	2.25 lb. / 1 kg	8 oz. / 236 ml
1 Scoop/Pump Treats	125 gal. / 472 L		25 gal. / 95 L	100 gal. / 378 L
1 Container/Bottle Treats	5,000 gal. / 18,900 L	40,750 gal. / 154,035 L	800 gal. / 3,024 L	5,000 gal. / 18,900 L
Packaged Weight	3 lb.	9.75 lb.	2.25 lb.	.75 lb.

K | F | P | A | L | PWR | WT | PC | SC | FC | APC | D | LUG | PP | IT | RH



[Click here to learn more about how each treatment works](#)

Pond & Debris Clarifier

- Quickly cleans unsightly debris
- Scientifically blended to quickly restore the water quality
- Reduces pond maintenance



Item Number	96002	96003	96005	96004	96006
MSRP	\$14.98	\$19.98	\$34.98	\$29.98	\$89.98
Package Size	8 oz. / 236 ml	16 oz. / 473 ml	32 oz. / 946 ml	32 oz. / 946 ml Pouch	1 gal. / 3.78 L
1 Tsp. Treats	50 gal. / 189 L				
1 Bottle Treats	2,500 gal. / 9,450 L	5,000 gal. / 18,900 L	10,000 gal. / 37,800 L	40,000 gal. / 151,400 L	100,000 gal. / 378,541 L
Packaged Weight	.75 lb.	1.25 lb.	2.5 lb.	2.25 lb.	8 lb.

SAB Stream & Pond Cleaner

- Breaks down debris
- Maintains a balanced ecosystem
- Reduces pond maintenance
- Phosphate binder



Item Number	98898	98899	98900	98896
MSRP	\$16.98	\$25.98	\$45.98	\$209.98
Package Size	4.4 oz. / 125 g	8.8 oz. / 250 g	1.1 lb. / 500 g	7 lb. / 3.2 kg
1 Scoop Treats	120 gal. / 454 L			1,420 gal. / 5,368 L
1 Container Treats	1,200 gal. / 4,536 L	2,400 gal. / 9,072 L	4,900 gal. / 18,597 L	31,240 gal. / 118, 256 L
Packaged Weight	.25 lb.	.75 lb.	1.25 lb.	7.5 lb.

▶ [Click here to learn more about how each treatment works](#)

Barley Straw Extract

- Promotes clean, clear water conditions in ponds and streams
- Starts working instantly
- Concentrated formulation with added enzymes



Item Number	98903	98904	98905	96012
MSRP	\$25.98	\$32.98	\$51.98	\$129.98
Package Size	8 oz. / 326 ml	16 oz. / 473 ml	32 oz. / 946 ml	1 gal. / 3.78 L
1 Pump Treats	100 gal. / 378 L			600 gal. / 2,268 L
1 Bottle Treats	5,000 gal. / 18,900 L	10,000 gal. / 37,800 L	20,000 gal. / 75,600 L	80,000 gal. / 302,400 L
Packaged Weight	.75 lb.	1.25 lb.	2.5 lb.	8 lb.

Rapid Clear Flocculant

- Quickly clears cloudy water by clumping debris
- Works within 24 hours
- For best results, use in combination with a Rapid Clear Fine Filter Pad (#80001)



#80001 Rapid Clear Fine Filter Pads

- Speeds-up filtering of flocculated particles
- Works within 24 hours
- For best results, use in combination with Rapid Clear Flocculant water treatments
- Enhances water quality
- Includes three pads



Item Number	98879	96049	40006	96007	80001
MSRP	\$20.98	\$25.98	\$32.98	\$116.98	\$32.98
Package Size	8 oz. / 236 ml	16 oz. / 473 ml	32 oz. / 946 ml	1 gal. / 3.78 L	12"W x 24"L
1 Pump Treats	100 gal. / 378 L		—	600 gal. / 2,268 L	—
1 Bottle Treats	5,000 gal. / 18,900 L	10,000 gal. / 37,800 L	20,000 gal. / 75,600 L	80,000 gal. / 302,400 L	—
Packaged Weight	.75 lb.	1.25 lb.	2.25 lb.	85 lb.	.75 lb.

Rapidly Resolves Pond Problems, Including Cloudy Water

Targets Ammonia, Nitrite, and Phosphate



Sits in a Solution Containing Special Blend of Treatments
Provides an instantaneous bio-available food source to maximize metabolic activity

Helps Control Organic Waste and Debris

Innovative Gummy For Quick and Easy Application

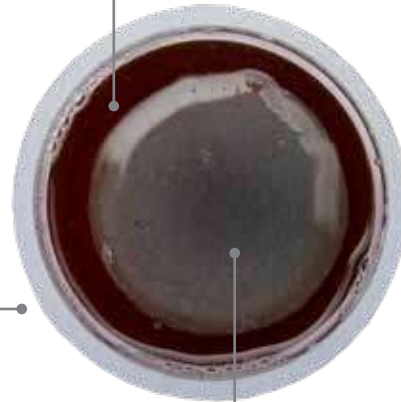

Each Gummy Contains

- 320 billion viable bacteria cultures specifically selected for their ability to quickly resolve a variety of pond problems
- Free enzymes which trigger digestion to help break down organics

#96083 QuickFix Pond Gummy

Packaged Weight: .25 lb.
1 Package Treats 3,000 gal. / 11,340 L

MSRP: \$12.98



Simply Open And Pour Into Your Pond

Cases Ship In Convenient Tear-Away Box!





▶ [Click here to learn more about how each treatment works](#)



#96029 Concentrated Barley Straw Pellets

- Fast-acting, natural way to clarify pond water
- Comes in a resealable mesh bag
- Contains a blend of bacteria and enzymes



#98884 Black Pond Dye

- Filters sunlight and cools water
- Contains humic acid and enzymes to help balance the pond ecosystem
- Creates a shimmering effect
- One dosage lasts up to 6 weeks



#98882 Blue Pond Dye

- Added enzymes help balance the pond ecosystem
- One dosage lasts up to 6 weeks

Item Number	96029	98884	98882
MSRP	\$32.98	\$21.98	\$23.98
Package Size	5 lb. / 2.3 kg	8 oz. / 236 ml	
1 Pump Treats	—	100 gal. / 378 L	
1 Container Treats	1,000 gal. / 3,780 L	5,000 gal. / 1,890 L	
Packaged Weight	5.5 lb.	.75 lb.	

Formulated for use with Aquascape AquaGardens

NEW



Specialized Water Treatment

For use with the Aquascape AquaGarden Mini Pond Kits (#78325, #78333) and AquaGarden Tabletop Fountain Kits (#78346, #78347)



4-in-1 Formulation

A powerful blend of beneficial bacteria and clarifiers, with scale and foam removers, keeps water clean, clear, healthy, and maintenance free



Convenient Dropper

Allows for precise dosing in smaller container water gardens

#96097 #96098 AquaGarden Maintenance 4-in-1

	#96097	#96098
Item Number	96097	96098
MSRP	\$19.98	\$32.98
For use with	AquaGarden Tabletop Fountain Kit	AquaGarden Mini Pond Kit
Package Size	2 fl. oz. / 59 ml	4 fl. oz. / 177 ml
Treatment Rate	Add 1 to 2 droppers every week	Add 5 droppers (2 tsp.) every week
1 Bottle Lasts	7 to 12 months	Up to 3 months
Packaged Weight	4.4 oz.	8.4 oz.

Fountain Treatments

WT

▶ [Click here to learn more about how each treatment works](#)



#40004 Patio Pond Maintenance Tabs

- Targeted treatment for container water gardens
- Contains 8 pure strains of beneficial bacteria
- Helps optimize water quality
- Safe for fish, animals, and plants



#98908 Fountain Foam Free

- Safely eliminates foam from water features
- Helps maintain the beauty of your water feature
- Helps keep water clean and clear of foam
- Safe for fish, animals, and plants



#96055 Rock & Fountain Cleaner

- Quickly eliminates debris from waterfalls, fountains, or streams
- Easy-to-use spray bottle application
- Safe for fish, animals, and plants



#40007 #96056 Fountain Maintenance

- Safely eliminates scale and debris build-up from water features
- Maintains the beauty of your water feature
- Helps maintain perfect water quality
- Prevents white scale build-up without damaging feature
- Safe for fish, animals, and plants



#98907 Fountain Scale Free

- Safely removes calcium and scale from water features
- Helps keep water clean and clear of hard water deposits, white scale, and foam
- Adds the fresh clean scent of lavender
- Safe for fish, animals, and plants

Item Number	40004	98908	96055	40007	96056	98907
MSRP	\$19.98	\$20.98	\$29.98	\$25.98	\$36.98	\$20.98
Package Size	36 Tabs	8 oz. / 236 ml	32 oz. / 946 ml	8 oz. 236 ml	16 oz. 473 ml	8 oz. / 236 ml
1 Tablet Treats	100 gal. 378 L			—		
1 Container Treats	3,600 gal. / 13,608 L			—		
1 Pump Treats	—	10 gal. / 37.8 L	—		10 gal. / 37.8 L	
1 Bottle Treats	—	500 gal. / 1,890 L	up to 300 sq. ft.	500 gal. / 1,890 L	1,000 gal. / 3,785 L	500 gal. / 1,890 L
Packaged Weight	.25 lb.	.75 lb.	2.5 lb.	.75 lb.	1.25 lb.	.75 lb.

K | F | P | A | L | PWR | WT | PC | SC | FC | APC | D | LUG | PP | IT | RH

Professional-Grade Water Treatments

▶ [Click here to learn more about how each treatment works](#)



#30406 Beneficial Bacteria Professional Grade

- Provides clean, clear, and healthy water conditions
- Contains photosynthetic bacteria
- Contains marigold and vitamin B



#30407 Beneficial Bacteria Concentrate Professional Grade

- Provides clean, clear, and healthy water conditions
- Contains 8 strains of bacteria
- Contains photosynthetic bacteria



#98895 Cold Water Beneficial Bacteria Professional Grade

- Provides clean, clear, and healthy water conditions
- Reduces ammonia, nitrite, and organic debris
- Ideal for use in water colder than 50°F (5°C)



#40011 Pond Starter Bacteria Professional Grade

- Establishes biological ecosystem
- Great for spring start-up and new ponds



#98897 Wetland Pond & Lake Bacteria Professional Grade

- Naturally reduces ammonia, nitrate, and excess nutrients
- Includes 8 pure strains of beneficial bacteria, including photosynthetic bacteria
- Maintains a balanced ecosystem



#30412 Rapid Clear Flocculant Professional Grade

- Clears discolored or cloudy water
- Clumps suspended debris (flocculation)
- Clears most ponds in 24 hours

Item Number	30406	30407	98895	40011	98897	30412
MSRP	\$129.99	\$259.99	\$129.99	\$129.99	\$155.99	\$129.99
Option			●			●
Package Size	1 gal / 3.78 L	9 lb / 4.08 kg	1 gal / 3.78 L			
1 Scoop Treats	6,000 gal. 22,680 L	48,000 gal. 181,440 L	6,000 gal. / 22,680 L		48,000 gal. 181,440 L	6,000 gal. 22,712 L
1 Container Treats	96,000 gal. 362,880 L	672,000 gal. 2,540,160 L	96,000 gal. / 362,880 L		768,000 gal. 2,903,040 L	96,000 gal. 363,400 L
Packaged Weight	9 lb.	9.5 lb.	9 lb.			

● Beneficial Bacteria ● Problem Solving

Professional-Grade Water Treatments

WT

▶ [Click here to learn more about how each treatment works](#)



#40010 Pond & Debris Clarifier Professional Grade

- Quickly cleans unsightly debris
- Restores water quality
- Reduces pond maintenance



#30409 SAB Stream & Pond Cleaner Professional Grade

- Keeps pond water clean and crystal clear
- Reduces pond maintenance
- Reduces ammonia and nitrates
- Phosphate binder



#30413 Waterfall & Rock Cleaner Professional Grade

- Spot treats the trouble areas on water features
- Quickly eliminates debris from waterfalls and rocks
- Reduces pond maintenance
- Goes to work instantly



#98906 Barley Straw Extract Professional Grade

- Natural way to clarify water
- Provides clear, clean pond conditions
- Starts working instantly
- Concentrated formulation with added enzymes



#40012 Ammonia Neutralizer Professional Grade

- Makes pond water safe for fish and plants
- Detoxifies chloramine in tap water
- Instantly neutralizes large concentrations of toxic ammonia





#30410 Pond Detoxifier Professional Grade



- Makes tap water safe for fish and plants
- Removes and detoxifies chlorine and chloramines
- Neutralizes ammonia
- Detoxifies and chelates copper and heavy metals



#30408 Sludge & Filter Cleaner Professional Grade

- Biological pond and filter cleaner
- Contains 5 strains of heterotrophic bacteria
- Contains marigold and humic acid

Item Number	40010	30409	30413	98906	40012	30410	30408
MSRP	\$103.99	\$259.99	\$103.99	\$142.99	\$129.99	\$129.99	\$129.99
Option							
Package Size	1 gal / 3.78 L	9 lb / 4.08 kg			1 gal / 3.78 L		
1 Scoop Treats	6,000 gal. / 22,712 L	3,000 gal. / 11,340 L	151-200 sq. ft.		6,000 gal. / 22,680 L		
1 Container Treats	96,000 gal. / 363,400 L	45,000 gal. / 170,000 L	3,650 sq. ft.		96,000 gal. / 362,880 L		
Packaged Weight		9.5 lb.		9.75 lb.	9 lb.	9.5 lb.	9.25 lb.

 Problem Solving  Water Conditioners  Sludge Fighting

K | F | P | A | L | PWR | WT | PC | SC | FC | APC | D | LUG | PP | IT | RH

Lake and Large Pond Treatments

▶ [Click here to learn more about how each treatment works](#)

Note: Aquascape lake treatments are optimized specifically for larger bodies of water and can cause issues when used in smaller water features.



#40013, #40014, #40015 Lake Bacteria Packs

- Restores the ecosystem, keeping water clean, clear, and healthy
- Easy-to-use water soluble packs make it easy to treat hard-to-reach areas
- Significantly reduces maintenance
- Fortified with prebiotics to enhance water quality

#40016 Lake Bacteria

- Restores the ecosystem, keeping water clean, clear, and healthy
- Significantly reduces maintenance
- Fortified with prebiotics to enhance water quality

Item Number	40013	40014	40015	40016
MSRP	\$103.99	\$194.99	\$272.99	\$77.99
Package Size	24 Packs	48 Packs	192 Packs	1 gal / 3.78 L
4 Packs Treat	1/4 acre for 1 month			—
1 Container Treats	Up to 1.5 acres	Up to 3 acres	Up to 12 acres	1/4 acre for 1-3 months
Packaged Weight	.75 lb.	1.25 lb.	2.5 lb.	9.25 lb.



#40017, #40018, #40019 Lake Sludge Remover Packs

- Quickly eliminates organic sludge and muck
- Easy-to-use water soluble packs make it easy to spot treat and treat hard-to-reach areas
- All active ingredients with no fillers or binders
- Slowly releases oxygen to maximize sludge reduction
- Added macrobiotics and carbon source

Item Number	40017	40018	40019
MSRP	\$103.99	\$194.99	\$454.99
Package Size	192 Packs	384 Packs	1,152 Packs
1 Pack Treats	250 ft ²		
1 Container Treats	48,000 ft ²	96,000 ft ²	288,000 ft ²
Packaged Weight	4.75 lb.	9.5 lb.	37 lb.

Lake and Large Pond Treatments



[▶ Click here to learn more about how each treatment works](#)

Note: Aquascape lake treatments are optimized specifically for larger bodies of water and can cause issues when used in smaller water features.



#40020, #40021, #40022 Lake Blue Dye Packs

- Shades water to prevent water quality issues
- Easy-to-use water soluble packs
- Significantly reduces maintenance, filters sunlight, and cools water temperature



#40023 Lake Flocculant Clarifier

- Quickly clears cloudy water caused by suspended particles
- Optimized to clarify clay, mineral material, and sediment issues
- Significantly reduces maintenance

Item Number	40020	40021	40022	40023
MSRP	\$32.99	\$64.99	\$233.99	\$103.99
Package Size	2 Packs	4 Packs	16 Packs	1 gal. / 3.78 L
1 Pack Treats	1.5 acre ft.			—
1 Container Treats	Up to 3 acre ft.	Up to 6 acre ft.	Up to 24 acre ft.	1/4 acres for 1-3 months
Packaged Weight	.75 lb.	1.25 lb.	2.5 lb.	9.25 lb.



#40024, #40025, #40026 Lake Phosphate Binder Packs

- Quickly binds phosphates to clean and clear water
- Easy-to-use water soluble packs
- Prevents and eliminates floating debris and debris that attaches to rocks and gravel
- Significantly reduces maintenance
- Binds orthophosphate



#40027, #40028, #40029 Lake Treatment Booster Packs

- Turbo boost the effects of all lake treatments
- Easy-to-use water soluble packs
- Adds oxygen directly to the water to accelerate nutrient uptake and sludge digestion
- Increases bacterial growth by up to ten times
- Great for non-aerated or highly eutrophic bodies of water

Item Number	40024	40025	40026	40027	40028	40029
MSRP	\$103.99	\$194.99	\$454.99	\$103.99	\$194.99	\$454.99
Package Size	192 Packs	384 Packs	1,152 Packs	192 Packs	384 Packs	1,152 Packs
1 Pack Treats	250 ft ²					
1 Container Treats	48,000 ft ²	96,000 ft ²	288,000 ft ²	48,000 ft ²	96,000 ft ²	288,000 ft ²
Packaged Weight	5 lb.	9.25 lb.	29 lb.	4.75 lb.	9.5 lb.	27.75 lb.

K | F | P | A | L | PWR | WT | PC | SC | FC | APC | D | LUG | PP | IT | RH

Predator Control

Add a little fun to your pond while helping to keep your koi and other pond fish safe.







Floating Alligator Decoy



Blue Heron Decoy

Item Number	93000	81030
MSRP	\$77.98	\$77.98
Dimensions	34"L x 6"W x 4"H	9"L x 6"W x 26"H
Primary Material	Polyresin	
Packaged Weight	2.5 lb.	2.25 lb.
Packaged Dimensions	11.5"L x 7.5"W x 10"H	28"L x 9"W x 6.25"H



Faux Log Fish Cave



Floating Swan Decoy

Item Number	78324	74014
MSRP	\$155.98	\$77.98
Dimensions	19"L x 12"W x 10"H	31"L x 15"W x 18"H
Primary Material	Polyresin	
Packaged Weight	11.5 lb.	5 lb.
Packaged Dimensions	22"L x 15"W x 13"H	31.25"L x 14.75"W x 9.25"H

A photograph of a pond in winter. The pond is partially frozen with snow and ice. There are several large, dark rocks scattered around the pond. In the background, there is a wooden fence and some evergreen trees covered in snow. The overall scene is a serene winter landscape.

Seasonal Care

Aquascape ecosystem ponds are naturally balanced and require very little care. You can easily maintain the health of your pond throughout the year with our comprehensive line of seasonal products.



Seasonal Pond Products

Smart Pond Thermometer

Give yourself peace of mind and eliminate guesswork by using accurate, real time temperature data to help manage your pond throughout the changing seasons. Receive friendly notifications on your smart phone when water temperature is ideal to start feeding your fish in the spring, switch to Cold Water Fish Food, and even change to Cold Water Beneficial Bacteria. [See page 129](#) for more information.



Spring



- Cold Water Beneficial Bacteriasee page 108
- Premium Cold Water Fish Food Pelletssee page 136
- Pond Starter Bacteriasee page 109



Summer



- Pond Aeration Kits see page 73
- Premium Staple Fish Food Pellets.....see page 134
- Pond Detoxifiersee page 111



Fall



- Cold Water Beneficial Bacteriasee page 108
- Premium Cold Water Fish Food Pelletssee page 136
- Protective Pond Netting.....see page 131



Winter



- Pond Powerhead see page 64
- AquaForce® Solids-Handling Pond Pumps see page 60
- 300-Watt Pond De-Icersee page 130
- Pro Air Pond Aeration Kits see page 74



Temperature Indicator

Numeric temperature indicator displays current temperature in F or C (-20°F and 120°F / -28°C and 48°C)



WiFi Pairing

Allows for quick and easy connection to your smart phone or tablet

Integrated Display Panel

For use without smartphone or tablet

Weighted Base

Allows for quick and discreet placement



Smart Pond Thermometer Shown

	Smart Pond Thermometer	Smart Pond Thermometer with Transformer
Item Number	74012	74013
MSRP	\$103.98	\$129.98
Wattage	1	
12V Transformer	Required (Sold Separately)	✓
Probe Size	1.75" diameter	
Power Cord Length	3'	
Probe Cord Length	20'	
Warranty	3-Year Limited	
Packaged Weight	1 lb.	1.5 lb.
Packaged Dimensions	5.5"L x 2.55"W x 5.7"H	



Submersible Pond Thermometer

Packaged Weight: .25 lb.

Packaged Dimensions: 5" L x 9"W x 1"H

MSRP: \$16.98

#74000

Pond De-Icer

Built-In LED Light

Indicates when the unit is operating

Internal Thermostat

Acts as a safety feature and signals built-in LED light



Stainless Steel Construction

Prevents corrosion and cracking

#39000 300-Watt Pond De-Icer

Packaged Weight: 4.5 lb.
 Dimensions: 5.5" Diameter x 4"H with 22' Cord
 Packaged Dimensions: 9"L x 9"W x 7"H
MSRP: \$229.98



300-Watt Pond De-Icer

The Aquascape 300-Watt Pond De-Icer is ideal for keeping a small hole in the ice during cold winter months and ensures proper gas exchange, helping keep fish alive throughout the winter. Maintaining an opening in the surface of the ice is paramount for the safety of pond fish.

Protective Pond Netting

SC



Protective Pond Netting 14' x 20' Shown



Bulk Protective Pond Netting 20' x 100' Shown

Compare Protective Pond Netting

	7' x 10'	14' x 20'	28' x 30'	Bulk 10' x 100'	Bulk 20' x 100'	Bulk 30' x 100'
Item Number	98000	98001	98002	74007	74002	74003
MSRP	\$20.98	\$38.98	\$89.98	\$233.99	\$349.99	\$495.99
Packaged Weight	.75 lb.	1.1 lb.	2.5 lb.	8 lb.	14.5 lb.	20.5 lb.
Packaged Dimensions	5.5"L x 3"W x 9"H	7.25"L x 4.75"W x 15"H	10.5"L x 50"W x 5"H	20"L x 18"W x 10"H	20"L x 18"W x 13"H	21"L x 23"W x 18"H



U-Shaped Ground Stakes 100 pieces

Ideal for securing or anchoring netting over ponds and waterfalls. The durable and sturdy landscape staples are 3" long with 11-gauge thickness, making them perfect for use around the perimeter of water features.

Packaged Weight: 1.75 lb.

Packaged Dimensions: 7"L x 1.5"W x 8"H

MSRP: \$24.99

#74008

A photograph of a pond filled with several colorful koi fish. The fish are swimming in clear, blue-green water. The colors of the koi include bright yellow, white with black and red spots, and various shades of red and orange. The fish are scattered throughout the frame, with some in the foreground and others in the background. The lighting is bright, creating a vibrant scene.

Fish Care

Keep your fish happy and healthy with Aquascape koi and pond fish products. From fish food to pond nets, you'll find what you need to care for your finned friends.



Premium Staple Fish Food Pellets

High-Quality Protein

Contains high-quality protein, including herring and shrimp

Healthy

Rich in amino acids, fats, minerals, and stabilized vitamins such as vitamin C



Reduces Maintenance

Low in phosphates and minimizes fish waste

Probiotics and Prebiotics

Aids in proper digestion, optimizes growth, and helps keep water clean

Compare Premium Staple Fish Food Pellets

Item Number	98867	98868	98869	81049	81007	50003	81050	81051	81052	81053
MSRP	\$16.98	\$24.98	\$44.98	\$89.98	\$149.98	\$298.98	\$16.98	\$24.98	\$44.98	\$89.98
Weight	1.1 lb. 500 g	2.25 lb. 1 kg	4.4 lb. 2 kg	11 lb. 5 kg	22 lb. 10 kg	44 lb. 20 kg	1.1 lb. 500 g	2.25 lb. 1 kg	4.4 lb. 2 kg	11 lb. 5 kg
Pellet Size	Small		Large				Mixed			
Feeding Temperature	Minimum water temperature of 60°F/15°C									
Recommendation	Ideal for fish from 3" (8 cm) and above		Ideal for fish from 8" (20 cm) and above				Ideal for all size fish			

Premium Color Enhancing Fish Food Pellets



Color Enhancing
Formulated to enhance and brighten colors in pond fish



Healthy
Provides all the same health benefits as our staple formula

High-Quality Ingredients
Protein sources include krill, herring, and shrimp

Reduces Maintenance
Low in phosphates and minimizes fish waste

Compare Premium Color Enhancing Fish Food Pellets

Item Number	98873	98874	98875	81048	81005	81006
MSRP	\$22.98	\$36.98	\$51.98	\$116.98	\$199.98	\$389.98
Weight	1.1 lb. / 500 g	2.25 lb. / 1 kg	4.4 lb. / 2 kg	11 lb. / 5 kg	22 lb. / 10 kg	44 lb. / 20 kg
Pellet Size	Small			Large		
Feeding Temperature	Minimum water temperature of 60°F/15°C					
Recommendation	Ideal for fish from 3" (8 cm) and above			Ideal for large fish from 8" (20 cm) and above		

Premium Cold Water Fish Food Pellets

Cold Water Formula

Can be fed in water temps as cold as 50°F

Nutrition

Includes stabilize multivitamin



Wheatgerm

Includes wheatgerm to help prepare the fish for a healthy winter

Protective Packaging

Re-sealable foil bag to protect from moisture, air and light

Compare Premium Cold Water Fish Food Pellets

Item Number	98870	98871	98872	81047	81003	81004
MSRP	\$22.98	\$35.98	\$51.98	\$116.98	\$199.98	\$389.98
Weight	1.1 lb. / 500 g	2.25 lb. / 1 kg	4.4 lb. / 2 kg	11 lb. / 5 kg	22 lb. / 10 kg	44 lb. / 20 kg
Pellet Size	Small			Large		
Feeding Temperature	Minimum water temperature of 50°F/10°C					
Recommendation	Ideal for fish from 3" (8 cm) and above			Ideal for large fish from 8" (20 cm) and above		

Color-Enhancing

Formulated to enhance and brighten colors in all pond fish



Probiotics

Easy to digest and reduces fish waste

#98878 Premium Fish Food Flakes 4.2 oz. / 119 g

Packaged Weight: .5 lb.

Packaged Dimensions: 3.5"L x 3.5"W x 7.5"H

MSRP: \$22.98

Ideal For Hand Feeding

The size, shape, and taste of the Koi Krunchies make them a perfect tool for training your fish to hand feed



Nutritious Treat

Contains high-quality ingredients and natural citrus flavors

Great Source of Vitamin C

Aquascape Koi Krunchies aid in proper tissue formation, digestion, and disease resistance

#81000 Koi Krunchies 1.1 lb. / 400 g

Packaged Weight: 1.25 lb.

Packaged Dimensions: 6"L x 6"W x 10"H

MSRP: \$28.98



Compare Pond Nets



Pond Skimmer Net with Extendable Handle

Heavy Duty Pond Skimmer Net with Extendable Handle

Professional-Grade Pond Skimmer Net

Pond Shark

Pond Shark Pro

Item Number	98559	98562	50001	74004	74005
MSRP	\$27.98	\$49.98	\$103.99	\$64.98	\$103.98
Handle Length	32", extends to 63"	36", extends to 63"	40"	Extends up to 60"	Extends up to 96"
Packaged Weight	.75 lb.	1.4 lb.	2 lb.	2.1 lb.	
Dimensions	12"L x 7"W	15"L x 15"W	23"L x 20.5"W Net	12"L x 8"W x 12"D	
Recommended Usage	Removing fine debris				



Compare Pond Nets

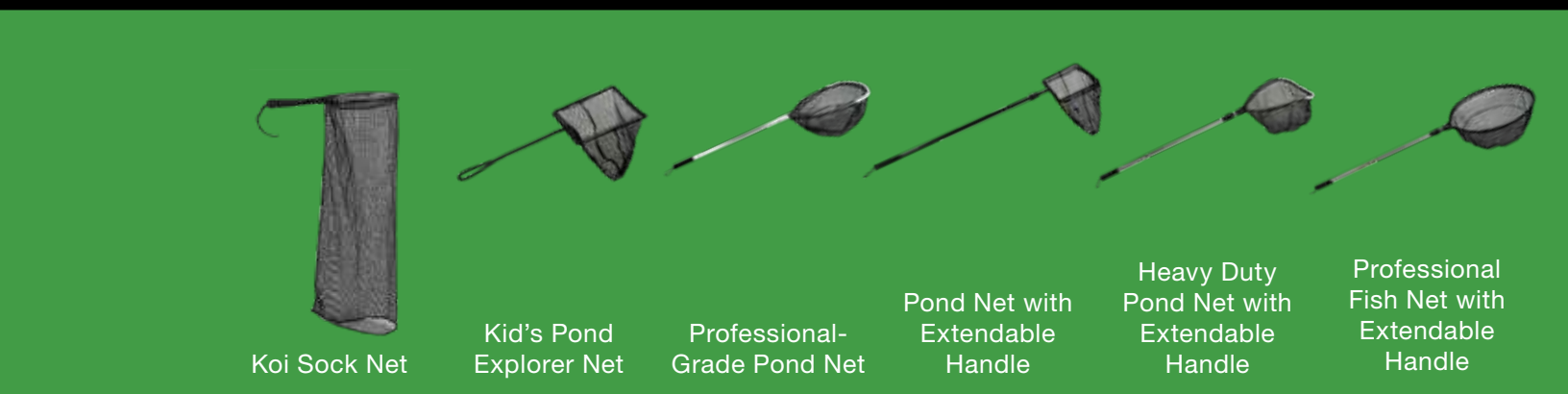

Koi Sock Net

Kid's Pond Explorer Net

Professional-Grade Pond Net

Pond Net with Extendable Handle

Heavy Duty Pond Net with Extendable Handle

Professional Fish Net with Extendable Handle

Item Number	81057	98556	50000	98558	98560	98561
MSRP	\$77.98	\$14.98	\$103.99	\$27.98	\$49.98	\$59.98
Handle Length	8"	12"	40"	32", extends up to 63"	36", extends up to 69"	32", extends up to 69"
Packaged Weight	1.2 lb.	.2 lb.	2 lb.	.75 lb.	1.4 lb.	2.1 lb.
Dimensions	24"L x 13"W x 38.5"D	10"L x 7"W	23"L x 20.5"W Net	12"L x 7"W	15"L x 15"W	22" diameter head
Recommended Usage	Catching/transporting fish	Catching small fish or removing debris	Catching fish and removing large debris			Catching fish

A photograph of a pond filled with lily pads. In the foreground, several large, green lily pads float on the water. A vibrant pink lotus flower is in full bloom on the right side. The background shows more lily pads and a small orange fish swimming in the water.

Aquatic Plant Care

Aquatic plants are an important part of the water garden. They provide beauty and naturalization with a huge array of plant choices. Most importantly, they help balance the pond's ecosystem and provide valuable biological filtration that removes nitrogen, ammonia, nitrates, and other minerals from pond water.





Compare Aquatic Planters



Aquatic Planter
6" x 6"
(2-pack)

Aquatic Planter
8" x 6"
(2-pack)

Aquatic Planter
12" x 8"
(2-pack)

Aquatic Lily
Planter-14" x 7"
(2-pack)

Floating Plant
Island

Item Number	98501	98502	98500	98929	89006
MSRP	\$8.98	\$10.98	\$12.98	\$16.98	\$51.98
Packaged Weight	.25 lb.		.5 lb.		
Dimensions	6" Diameter x 6"H	8" Diameter x 6"H	12" Diameter x 8"H	14" Diameter x 7"H	15"L x 11"W x 4"H
Packaged Dimensions	6.5"L x 7"W x 1"H	11.5"L x 8"W x 1"H	12"L x 8"W x 5"H	12"L x 9.5"W x 1"H	16"L x 4"W x 12.5"H

All-Natural

Non-toxic alluvial planting media



Fine-Grained Media

Perfect for planting or re-potting water lilies, marginals and other aquatic plants

Peat Moss and Compost Free

Supports growth of aquatic plants and safe for pond fish

Compare Pond Plant Potting Media

Item Number	89002	89003
MSRP	\$16.98	\$27.98
Covers	215 cubic inches / 0.0035 cubic meters	432 cubic inches / 0.007 cubic meters



Pond Plant Potting Media

Aquascape Pond Plant Potting Media is an all-natural, non-toxic alluvial planting media perfect for supporting the growth of aquatic plants. Each bag is free of peat moss or compost and completely safe for your pond fish.

Decorative Water Features

Decorative water features are a unique and easy way to add a splash of water or a flicker of fire to any outdoor living space.

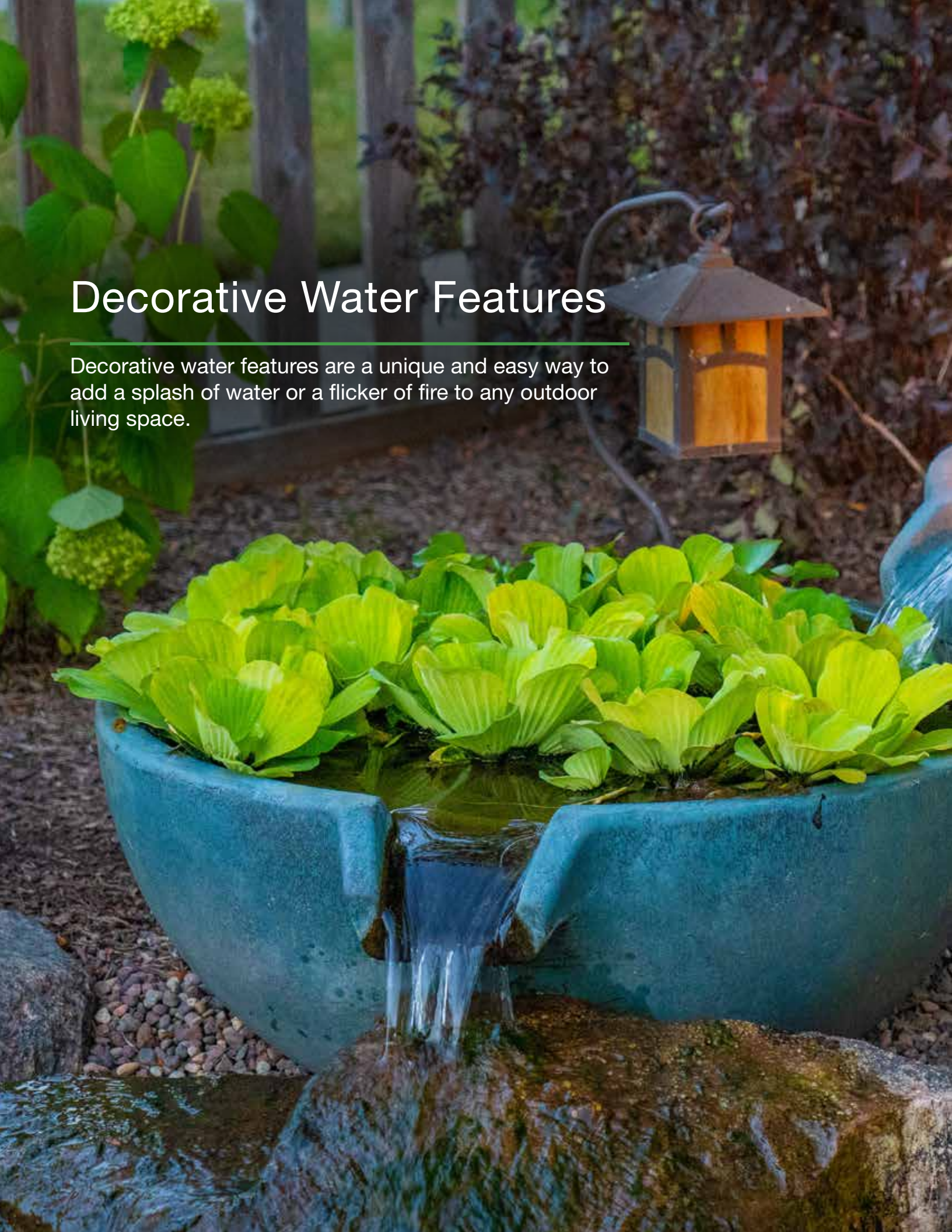



Melt

The Stress Away



Auto-Ignite Systems

Excite your senses with a complete, turn-key, auto-ignite feature like the Fire and Water Spillway Bowl, Fire and Water Spillway Basin, Fire and Water Stacked Slate Sphere, Faux Stone Fire Pit, or Stacked Slate Urn-Large.



Aquascape fire and water features combine the beauty of fire and water to enhance your backyard.



Match-Lit Systems

Enhance Aquascape basalt columns with the mesmerizing and therapeutic effects of fire or add a decorative fire fountain to any patio or garden.

Fire and Water 3-Piece Basalt Torch System



Proprietary Brass Burner Torches

Combines fire and water into unique, impressive design



Complete Kit

Includes everything to add torches to 3 columns

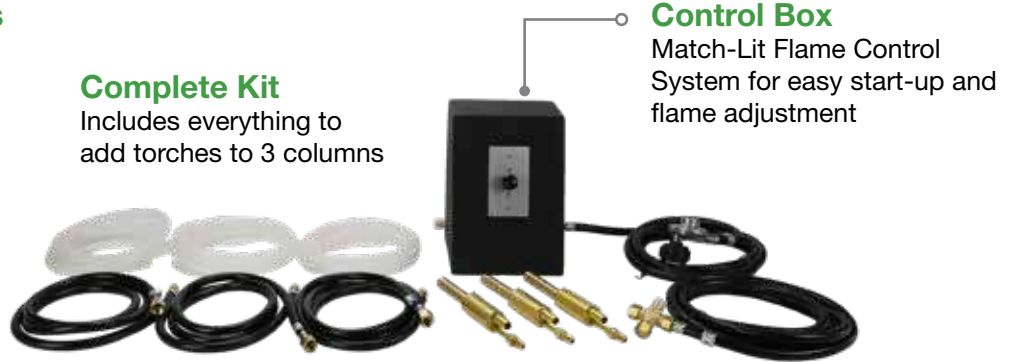

Control Box

Match-Lit Flame Control System for easy start-up and flame adjustment

#58103 Fire and Water 3-Piece Basalt Torch System

Packaged Weight: 20 lb.

Packaged Dimensions: 18"L x 14"W x 14"H

Recommended Pump: Ultra 2000 Water Pump #91010

MSRP: \$1,239.99

Includes

- (3) torches
- Water tubing
- Rubber gas line
- Match-Lit Flame Control System
- Gas tubing with splitter
- Propane tank regulator

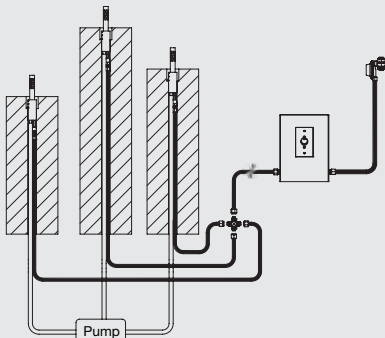

Enhance Aquascape Natural Basalt Columns with Fire!

These innovative torches install quickly into the top of the column. Compatible with Aquascape Natural Stone Basalt Columns. Pump and basalt columns sold separately.

NOTE: Not compatible with Aquascape Faux Basalt Columns.

Fire and Water Basalt Column Torches

D



Customize your own installation using the a la carte components



Fire and Water
Basalt Column
Torch



Match-Lit Flame
Control System



Rubber Gas
Hose—
3/8" x 10'



Rubber Gas
Hose—
3/8" x 20'



4-Way 3/8"
Splitter with
Caps



Propane Tank
Regulator and
Hose—3/8" x10'

Item Number	58101	58102	58111	58112	58109	58104
MSRP	\$272.99	\$376.99	\$77.99	\$90.99	\$25.99	\$77.99
Dimensions	9.5"L x 1.5"W x 1.5"H	7.25"L x 7"W x 10"H	3/8" x 10'	3/8" x 20'	2.5"L x 2.5"W x .75"H	3/8" x 10'
Includes	<ul style="list-style-type: none"> Water tubing—1/2" x 6' Rubber gas hose—1/4" x 6' with 3/8" connection 			—		
Recommended Pump	Ultra 2000 Water Pump #91010			—		
Packaged Weight	1 lb.	12 lb.	1.5 lb.	2.5 lb.	1 lb.	1.25 lb
Packaged Dimensions	10"L x 2"W x 2"H	15.75"L x 12"W x 10"H	10"L x 10"W x 2.5"H	12"L x 14"W x 2.5"H	3"L x 3"W x 1"H	8"L x 8"W x 3"H

NOTE: Fire and Water Torches not compatible with Faux Basalt Columns

K | F | P | A | L | PWR | WT | PC | SC | FC | APC | D | LUG | PP | IT | RH

Auto-Ignite Fire Features

CSA Certified System

Certified system with thermocouple sensor ensures safe operation

Automatic Ignition

Quick and easy startup with the press of a button

High-End Burner System

12" stainless steel burner ring provides impressive 60,000 BTU flame output

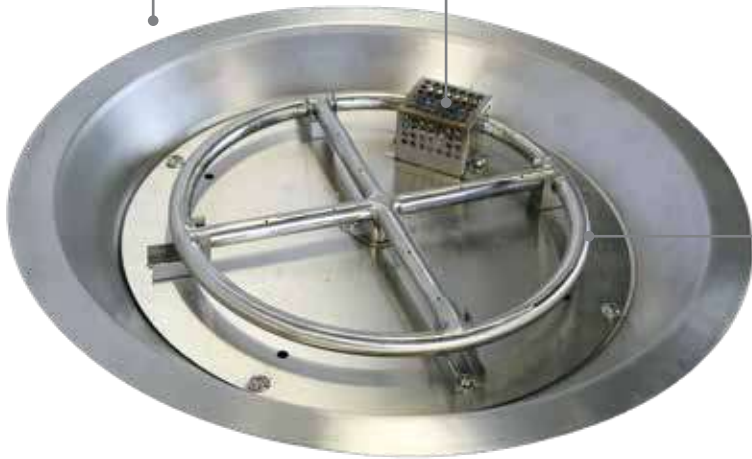

Flame Control System

Push-button ignition with internal safety valve

Easy Flame Adjustment

Simply turn the knob for seamless flame height control

Easy Setup

Weather-proof power connection and 3/8" flared gas hookup



Each Auto-Ignite Feature Includes:



• Feature with Burner System



• Flame Control System



• Propane Tank Regulator



• Gas Hose and Power Cable



• Water Tubing

Auto-Ignite Fire Features

D

NEW



NEW

Fire Media
Sold Separately
[See page 154](#)



Fire and Water Spillway Basin



Fire and Water Spillway Bowl

Item Number	58116	58092
MSRP	\$4,939.99	\$4,549.99
Dimensions	40"L x 40"W x 16"H	34"L x 32"W x 15"H
Primary Material	Fiber-Resin	
Includes	Fire and water feature, control system, gas tubing, power cable, water tubing, and propane tank regulator	
Recommended Pump	Ultra 2000 Water Pump #91010 (Sold Separately)	
Recommended Basin	AquaBasin® 45 or custom using AquaBlox®	
Packaged Weight	109 lb.	73 lb.
Packaged Dimensions	51"L x 42.5"W x 20"H	35"L x 35"W x 17.5"H

K | F | P | A | L | PWR | WT | PC | SC | FC | APC | **D** | LUG | PP | IT | RH

Auto-Ignite Fire Features



Fire Media
Sold Separately
[See page 154](#)



Fire and Water Stacked Slate Sphere



Fire and Water Stacked Slate Urn

Item Number	58093	58114
MSRP	\$5,199.99	\$4,469.98
Dimensions	32" Diameter x 24"H	35.5"L x 35.5"W x 55"H
Primary Material	Fiber-Resin	
Includes	Fire and water feature, control system, gas tubing, power cable, water tubing, and propane tank regulator	
Recommended Pump	Ultra 2000 Water Pump #91010	
Recommended Basin	AquaBasin® 45 or custom using AquaBlox®	Custom using AquaBlox®
Packaged Weight	127.75 lb.	203 lb.
Packaged Dimensions	35"L x 35"W x 21.75"H	38"L x 37.5"W x 34.6"H

Auto-Ignite Fire Features

D



Fire Media
Sold Separately
[See page 154](#)



Faux Stone Fire Pit

Item Number	58091
MSRP	\$4,289.99
Dimensions	41.54"L x 34.25"W x 14.25"H
Primary Material	GFRC
Includes	Fire pit, control system, gas tubing, power cable, and propane tank
Packaged Weight	175.5 lb.
Packaged Dimensions	43.5"L x 35.5"W x 15.75"H



Mixed Tumbled Lava Stones Shown



1/4" Reflective Black Fire Glass Shown

Black



Cobalt Blue



Aquamarine



Compare Fire Media

	Medium Tumbled Lava Stones	Large Tumbled Lava Stones	Mixed Tumbled Lava Stones	1/4" Reflective Black Fire Glass	1/4" Reflective Cobalt Blue Glass	1/4" Aquamarine Fire Glass
Item Number	78316	78317	78318	78262	78263	78264
MSRP	\$64.98	\$64.98	\$116.98	\$77.98	\$77.98	\$77.98
Packaged Weight	25 lb.		50 lb.	10.5 lb.		

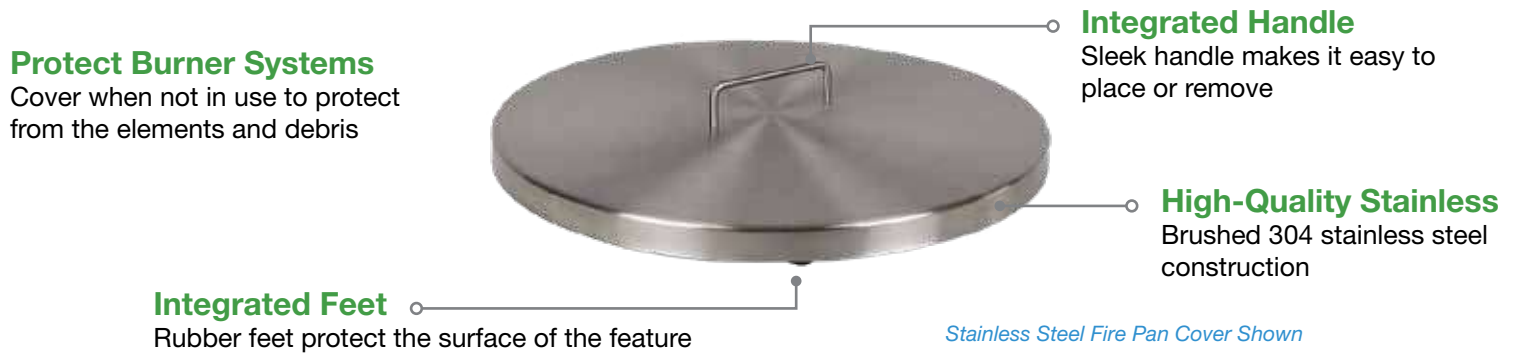

Compare Propane Tank Covers



Faux Stone



Faux Stump



Stainless Steel Fire Pan Cover

Item Number	78336	78345	58115
MSRP	\$324.98	\$169.98	\$199.98
Dimensions	16.5"L x 16.5"W x 21.25"H	15"L x 15"W x 18"H	21.25" Diameter x 1.75"H
Packaged Weight	41.25 lb.	14 lb.	5.25 lb.
Packaged Dimensions	19.5"L x 19.5"W x 23.5"H	17.5"L x 17.5"W x 21"H	21"L x 24"W x 2.5"H

D

Water Feature Basins

AquaBasin underground reservoirs make it easy to install a variety of Aquascape water features

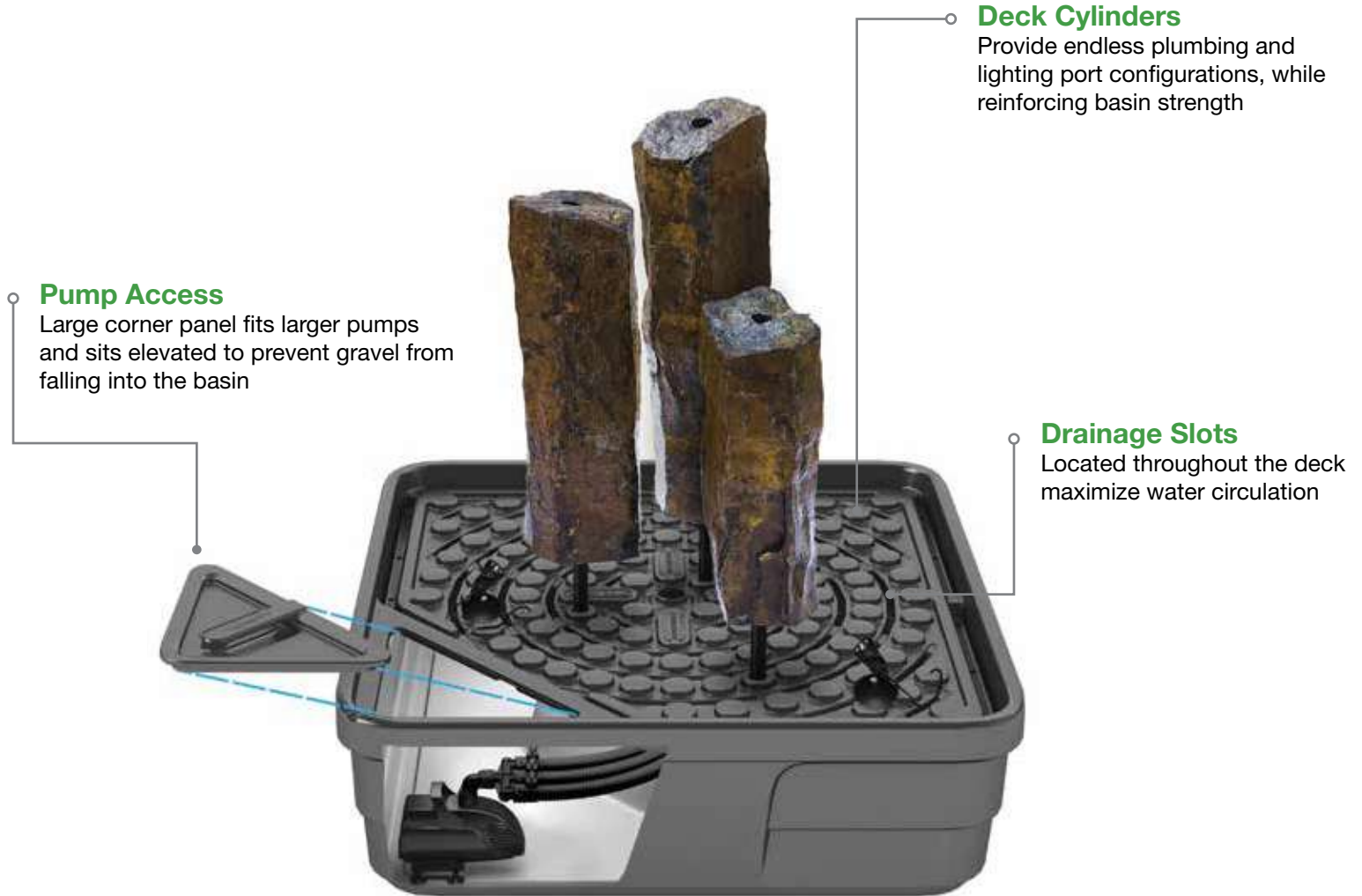

AquaBasin® 45 Shown



Trouble-Free, Easy-To-Install

Aquascape AquaBasins® make decorative water feature installations quick, easy, and trouble-free. Install natural stone fountains, bubbling urns, spillway bowls, and even small waterfalls with ease. Multiple versions are available depending on the size of your decorative water feature.



Compare Water Feature Basins

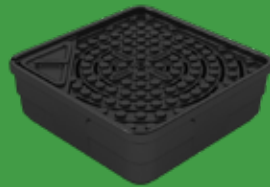

AquaBasin® 30



AquaBasin® 45



DecoBasin

Item Number	78223	78224	60000
MSRP	\$519.98	\$899.98	\$155.98
Dimensions	30"L x 20"W x 12"H	44.5"L x 44.5"W x 16"H	22" Diameter x 14.25"H
Water Storage Capacity	27 gal.	98 gal.	15 gal.
Maximum Flow Rate	2,000 GPH	4,000 GPH	1,500 GPH
Weight Capacity	500 lb.	1,500 lb.	100 lb.
Warranty	Limited Lifetime		1-Year Limited
Packaged Weight	22 lb.	60 lb.	9 lb.

K | F | P | A | L | PWR | WT | PC | SC | FC | APC | D | LUG | PP | IT | RH

Faux Basalt Column Sets

NEW

Natural Stone Appearance

Molded from real stone for natural look and feel

Water Outlet

Recessed water outlet with included tubing and fitting for easy install

Lightweight and Durable

Handmade using fiberglass, resin, and real stone

Sturdy Base

Provides support to stabilize the fountain

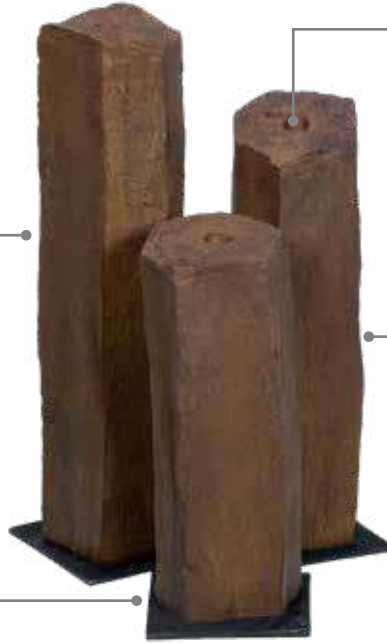

Faux Basalt Columns - Set of 3 Shown



Faux Basalt Columns - Set of 3



Faux Basalt Columns - Set of 5

Item Number	78367	78368
MSRP	\$1,799.98	\$2,999.98
Dimensions	See column dimensions on page 159	
Primary Material	Fiber-Resin Composite	
Included Tubing	(3) 3/4" x 6'	(5) 3/4" x 6'
Recommended Pump	Ultra 2000 Water Pump #91010	AquaSurge 2000 Pond Pump #91017
Recommended Basin	AquaBasin® 45 #78224	Custom using AquaBlox®
Packaged Weight	34.5 lb.	56 lb.

NOTE: Faux Basalt Columns not compatible with Fire and Water Torches



Illuminate the Water as it Rises!

Bring your fountain to life at night with AquaScape LED Fountain Lights! Each light installs easily into the top of the fountain. Choose between Warm White (see page 88) or Color-Changing (see page 82).

Faux Basalt Columns

D

NEW



Kit Available
See page 25



18"

24"

30"

36"

42"

Item Number	78361	78362	78363	78364	78365
MSRP	\$359.98	\$549.98	\$619.98	\$749.98	\$869.98
Dimensions	18"H with 10" Base	24"H with 10" Base	30"H with 10" Base	36"H with 12" x 10" Base	42"H with 12" x 10" Base
Primary Material	Fiber-Resin Composite				
Included Tubing	✓				
Recommended Pump	Ultra 400 Water Pump #91005		Ultra 800 Water Pump #91007		Ultra 1100 Water Pump #91008
Recommended Basin	AquaBasin® 30 #78223 or DecoBasin #60000		AquaBasin® 45 #78224 or custom using AquaBlox®		
Packaged Weight	12 lb.	15 lb.	17 lb.	20 lb.	22 lb.

NOTE: Faux Basalt Columns not compatible with Fire and Water Torches

K | F | P | A | L | PWR | WT | PC | SC | FC | APC | D | LUG | PP | IT | RH

D

Straight Stacked Slate Walls



Mix and Match Walls and Toppers for a Unique Design



Quad-Spill Straight Topper

Front-Spill Straight Topper

Small Straight Wall Base

Large Straight Wall Base

Item Number	78280	78281	78279	78278
MSRP	\$349.98	\$349.98	\$609.98	\$839.98
Dimensions	36"L x 12"W x 6"H		36"L x 12"W x 13"H	36"L x 12"W x 26"H
Primary Material	Fiber-Resin			
Included Tubing	✓		—	
Recommended Pump	—		Ultra 2000 Water Pump #91010	
Recommended Basin	—		AquaBasin® 45 #78224 or custom using AquaBlox®	
Packaged Weight	18.75 lb.		24 lb.	41 lb.

Curved Stacked Slate Walls

D



Kit Available
See page 23



Front-Spill
Curved Topper

Rear-Spill
Curved Topper

Quad-Spill
Curved Topper

Small Curved
Wall Base

Large Curved
Wall Base

Item Number	78284	78285	78286	78283	78282
MSRP	\$349.98	\$349.98	\$349.98	\$609.98	\$899.98
Dimensions	36"L x 12"W x 6"H			36"L x 12"W x 13"H	36"L x 12"W x 26"H
Primary Material	Fiber-Resin Composite				
Included Tubing	✓			—	
Recommended Pump	—			Ultra 2000 Water Pump #91010	
Recommended Basin	—			AquaBasin® 45 #78224 or custom using AquaBlox®	
Packaged Weight	19.25 lb.	17.5 lb.	19.25 lb.	22.75 lb.	39 lb.

K | F | P | A | L | PWR | WT | PC | SC | FC | APC | D | LUG | PP | IT | RH

Stacked Slate Spheres



Kit Available
See page 23

Compare Stacked Slate Spheres

	Small	Medium	Large
Item Number	78287	78288	78289
MSRP	\$709.98	\$1,169.98	\$1,949.98
Dimensions	24" Diameter x 22"H	32" Diameter x 30"H	40" Diameter x 37.5"H
Primary Material	Fiber-Resin		
Included Tubing	Silicone 3/4" x 35"	Silicone 3/4" x 47"	Silicone 3/4" x 55"
Recommended Pump	Ultra 800 Water Pump #91007	Ultra 1500 Water Pump #91009	Ultra 2000 Water Pump #91010
Recommended Basin	AquaBasin® 45 #78224		Custom using AquaBlox®
Packaged Weight	26 lb.	68 lb.	111 lb.



Fire Fountain Add-On Kit

Prepare to be amazed at the difference fire can make for your fountain. Ideal for use with Stacked Slate Spheres and Stacked Slate Urns.

MSRP: \$155.98

[#78221](#)



Compare Stacked Slate Urns

	Small	Medium	Large
Item Number	98939	78207	98940
MSRP	\$709.98	\$1,169.98	\$1,949.98
Dimensions	21.25" Diameter x 33.5"H	27" Diameter x 45"H	35.5" Diameter x 55"H
Primary Material	Fiber-Resin		
Included Tubing	Silicone 1/2" x 53"	Silicone 3/4" x 55"	Silicone 3/4" x 71"
Recommended Pump	Ultra 550 Water Pump #91006	Ultra 1100 Water Pump #91008	Ultra 2000 Water Pump #91010
Recommended Basin	AquaBasin® 30 #78223 or DecoBasin #60000	AquaBasin® 45 #78224	Custom using AquaBlox®
Packaged Weight	34.5 lb.	56 lb.	104 lb.



Small Stacked Slate Urn Fountain Kit

Packaged Weight: 38 lb.

Dimensions: 21.25" Diameter x 33.5"H

Basin Dimensions: 22" Diameter x 14.25"H

Packaged Dimensions: 22.5"L x 22.5"W x 37.75"H

MSRP: **\$969.98**

[#58064](#)

D

Scalloped Urns



Kit Available
See page 22

Compare Scalloped Urns

	Small	Medium	Large
Item Number	78238	78239	78240
MSRP	\$709.98	\$1,169.98	\$1,949.98
Dimensions	20" Diameter x 32"H	27" Diameter x 45"H	38" Diameter x 56"H
Primary Material	Fiber-Resin		
Included Tubing	Silicone 1/2" x 53"	Silicone 3/4" x 55"	Silicone 3/4" x 71"
Recommended Pump	Ultra 550 Water Pump #91006	Ultra 1100 Water Pump #91008	Ultra 2000 Water Pump #91010
Recommended Basin	AquaBasin® 30 #78223 or DecoBasin #60000	AquaBasin® 45 #78224	Custom using AquaBlox®
Packaged Weight	26 lb.	50 lb.	93 lb.



Fire Fountain Add-On Kit

Prepare to be amazed at the difference fire can make for your fountain. Ideal for use with Scalloped Urns.

MSRP: \$155.98

[#78260](#)

Spillway Bowl, Basin, and Stand

D

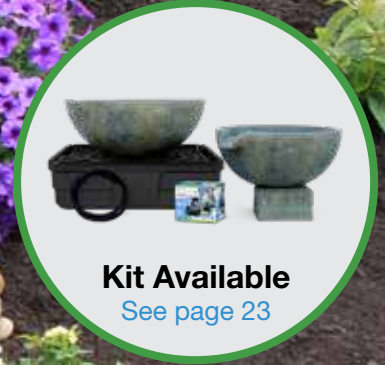

Kit Available
See page 23



Spillway Basin 40"



Spillway Bowl 32"



Spillway Bowl Stand
(2-pack)

Item Number	78205	78204	78206
MSRP	\$1,039.98	\$699.98	\$169.98
Dimensions	40"L x 40"W x 16"H	32"L x 32"W x 14.5"H	13.5"L x 13.5"W x 4"H
Primary Material	GFRC		
Recommended Pump	Ultra 2000 Water Pump #91010		—
Recommended Basin	AquaBasin® 45 #78224		—
Packaged Weight	119 lb.	70.25 lb.	33.5 lb.

K | F | P | A | L | PWR | WT | PC | SC | FC | APC | D | LUG | PP | IT | RH

Stone Basalt Columns

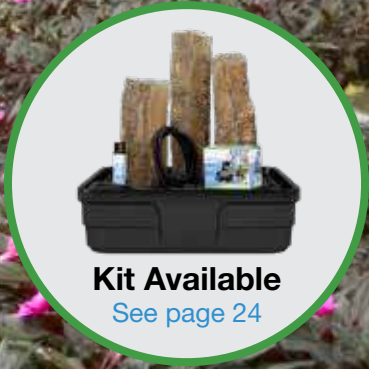

Compare Natural Mongolian Basalt Columns

	24"	30"	36"	Set of 3
Item Number	58038	98503	98969	58062
MSRP	\$779.98	\$949.98	\$1,169.98	\$2,599.98
Dimensions	10" Diameter x 24"H	10" Diameter x 30"H	10" Diameter x 36"H	24", 30", & 36" x 10" Diameter
Included Tubing	—			
Recommended Pump	Ultra 800 Water Pump #91007			Ultra 2000 Water Pump #91010
Recommended Basin	AquaBasin® 30 #78223	AquaBasin® 45 #78224		
Packaged Weight	200 lb.	335 lb.	375 lb.	850 lb.



Want to Add **FIRE?**

Enhance your new or existing Aquascape Basalt Columns with the mesmerizing therapeutic effects of fire. Aquascape Fire and Water 3-Piece Basalt Torch System (#58103) installs quickly and easily into the top of any existing or new aquascape basalt column. [See page 148](#)

NOTE: Fire and Water Torches not compatible with Faux Basalt Columns

AquaGarden Mini Pond Kit

Innovative Design
Makes it easy to add a water garden to any location

Pump Included
Pump with low-suction attachment maximizes water usage and circulation

Integrated Light
Illuminates the waterfall

Media Included
Kit includes two types of decorative gravel plus grow media for the upper waterfall

Kit Includes

- Plant and Waterfall Filter
- Waterfall Light
- Pump
- Decorative and Grow Media

AquaGarden Mini Pond Kit - Mocha Shown



AquaGarden Mini Pond Kit - Mocha

Packaged Weight: 19 lb.
Dimensions: 23.5" Diameter x 9.875"H
Packaged Dimensions: 24"L x 24"W x 14"H

MSRP: \$259.98

#78325



AquaGarden Mini Pond Kit - Gray

Packaged Weight: 19 lb.
Dimensions: 23.5" Diameter x 9.875"H
Packaged Dimensions: 24"L x 24"W x 14"H

MSRP: \$259.98

#78333



NEW AquaGarden Maintenance 4-in-1

This treatment is formulated specifically for use with Aquascape AquaGardens and other small container water gardens. This 4-in-1 formulation combines an ecosystem bacteria blend with special clarifiers, scale reducers, and foam reducers to keep your feature clean, clear, and maintenance free. [See page 116](#)



AquaGarden Mini Pond Kit Accessories

D



AquaGarden Plant Light



AquaGarden Stand

Item Number	78332	78331
MSRP	\$119.98	\$119.98
Features	Low-voltage transformer included	Durable, powder coated iron construction
Dimensions	8"L x 3.75"W x 18.25"H	13.25" Diameter x 16"H
Packaged Dimensions	20.5"L x 9"W x 4.25"H	15"L x 14"W x 4.5"H
Packaged Weight	1 lb.	8.8 lb.

K | F | P | A | L | PWR | WT | PC | SC | FC | APC | D | LUG | PP | IT | RH



Calming Qualities

Add a compact water garden to any indoor location. This complete kit includes everything you need to get started, and its compact size makes it great for offices, kitchens, and other indoor locations.



AquaGarden Tabletop Fountain Kit

D

Media Included

Includes grow media and decorative gravel for both the waterfall and pond

Overhead Plant Light

Illuminates the AquaGarden while helping plants grow

Plant and Waterfall Filter

Ideal location for plants while acting as a biological filter to keep the water clean and clear

Kit Includes

- Plant and Waterfall Filter
- Plant Light
- Waterfall Light
- Pump
- Controller with Transformer
- Decorative and Grow Media



AquaGarden Tabletop Fountain Kit - Gray Shown



AquaGarden Tabletop Fountain Kit - Mocha

Packaged Weight: 5.25 lb.
Dimensions: 11" Diameter x 5"H
Packaged Dimensions: 12.2"L x 12.2"W x 6.3"H

MSRP: \$119.98

#78346



AquaGarden Tabletop Fountain Kit - Gray

Packaged Weight: 5.25 lb.
Dimensions: 11" Diameter x 5"H
Packaged Dimensions: 12.2"L x 12.2"W x 6.3"H

MSRP: \$119.98

#78347



NEW AquaGarden Maintenance 4-in-1

This treatment is formulated specifically for use with Aquascape AquaGardens and other small container water gardens. This 4-in-1 formulation combines an ecosystem bacteria blend with special clarifiers, scale reducers, and foam reducers to keep your feature clean, clear, and maintenance free. [See page 116](#)





Compare Patio Ponds



Green Slate
32"

Green Slate
40"



Desert Granite
32"

Desert Granite
40"



European
Terra Cotta 32"

European
Terra Cotta 40"

Item Number	98856	98859	98857	98860	98858	98861
MSRP	\$739.98	\$1,139.98	\$739.98	\$1,139.98	\$739.98	\$1,139.98
Gallons/Liters	20 gal. / 75.71 L	30 gal. / 113.56 L	20 gal. / 75.71 L	30 gal. / 113.56 L	20 gal. / 75.71 L	30 gal. / 113.56 L
Packaged Weight	43.5 lb.	51 lb.	43.5 lb.	51 lb.	43.5 lb.	51 lb.
Dimensions	32"L x 32"W x 14"H	40"L x 40"W x 16"H	32"L x 32"W x 14"H	40"L x 40"W x 16"H	32"L x 32"W x 14"H	40"L x 40"W x 16"H



Integrated
Plant Shelf



Container Water Gardening

Both round and square models are made of durable fiber-resin and feature an integrated plant shelf, making it easy to create a natural paradise for your outdoor living space.



Compare Textured Gray Slate Patio Pond

	27"	33"
Item Number	78050	78051
MSRP	\$739.98	\$1,139.98
Dimensions	27"L x 27"W x 14"H	33"L x 33"W x 16"H
Gallons/Liters	27 gal. / 122.74 L	45 gal. / 204.57 L
Packaged Weight	43.5 lb.	34.5 lb.

Looking For A Smaller All-In-One Kit?

The Aquatic Patio Pond Kit is perfect for small spaces, measuring just 16" square. The kit includes a bamboo fountain and pump.



Aquatic Patio Pond Kit

Packaged Weight: 9 lb.

Dimensions: 16" sq. x 14"H (including bamboo fountain)

Packaged Dimensions: 19"L x 19"W x 10.5"H

MSRP: \$169.98

#78197

Bamboo Fountains



Pouring 3-Tier Bamboo Fountain Shown



Ideal For Use With The Aquascape Patio Pond

Bamboo fountains create the gentle sound of falling water, replicating historic designs displayed in Japanese gardens.

Bamboo Fountains

D



Deer Scarer



Pouring 3-Tier



Adjustable Pouring

Item Number	78306	78307	78308
MSRP	\$116.98	\$103.98	\$116.98
Dimensions	5.5"L x 4"W x 14"H	5"L x 3.25"W x 15.5"H	18-30"L x 4.5"W x 10"H
Primary Material	Polyresin		
Packaged Dimensions	18"L x 7"W x 8"H	18.5"L x 7.25"W x 7.5"H	22.25"L x 7.5"W x 9"H
Recommended Pump	90 GPH Water Pump #91024		
Packaged Weight	4.25 lb.	3.25 lb.	5.75 lb.

K | F | P | A | L | PWR | WT | PC | SC | FC | APC | D | LUG | PP | IT | RH

Fountain Spitters



Construction

Made of high-quality polyresin

UV Resistance

Resistant to UV and heat

Installation

Lightweight and easy to install

Toucan Spitter Shown



Add Some Fun to Your Water Feature

Spitters add a touch of excitement to your water features. Decorate your pond or waterfall with a Toucan Spitter, Naughty Dog Spitter, or any of our many spitters.

Fountain Spitters

D



Toucan



Naughty Dog



Lazy Frog on Lily Pad



Man in Barrel Spitter
*barrel not included

Item Number	78309	78310	78311	78315
MSRP	\$259.98	\$169.98	\$103.98	\$103.98
Dimensions	15"L x 9"W x 16"H	17"L x 12"W x 12.75"H	12"L x 10"W x 5"H	37.5"L x 8"W x 12"H Head: 8.5"L x 11"W x 8"H Hand: 4.5"L x 5"W x 3"H
Primary Material	Polyresin			
Recommended Pump	90 GPH Water Pump #91024			
Packaged Weight	10.25 lb.	8.5 lb.	4.25 lb.	3.75 lb.
Packaged Dimensions	19"L x 12.5"W x 19.5"H	20.5"L x 12"W x 12.75"H	13"L x 12"W x 7.5"H	12"L x 9"W x 14.5"H

K | F | P | A | L | PWR | WT | PC | SC | FC | APC | D | LUG | PP | IT | RH

D

Decorative Accessories



Faux Driftwood 30"



Faux Driftwood 35"



Faux Oak Stump Cover



Faux Log Fish Cave

Item Number	78276	78277	78259	78324
MSRP	\$129.98	\$155.98	\$169.98	\$155.98
Features	Ideal for concealing hard-to-hide water feature components, such as skimmers and spillways		Great for hiding outdoor electrical outlets, power cords and transformers	Provides pond fish shelter from predators
Dimensions	30"L x 4"W x 4"H	35"L x 4"W x 5"H	15" diameter x 18.5"H	19"L x 12"W x 10"H
Packaged Weight	4.5 lb.	7.5 lb.	19 lb.	11.5 lb.
Packaged Dimensions	31.75"L x 7"W x 10.5"H	36"L x 8"W x 10.75"H	18"L x 18"W x 21"H	22"L x 15"W x 13"H



Fountain Shims
(set of 6)



Tumbled Lava Stones



Decorative River
Pebbles-Black



Decorative River
Pebbles-Mixed

Item Number	78159	78316 78317 78318	78160	78161
MSRP	\$13.98	\$64.98 \$64.98 \$116.98	\$77.98	\$77.98
Features	Ideal for leveling resin, concrete, stone, or GFRC water fountains	Attractive accent to your water feature		
Dimensions	4.5"L x 1"W x .25"H	Medium Large Mixed	3" to 5"	
Surface Coverage	—	1.5 sq. ft.		
Packaged Weight	.5 lb.	25 lb. 25 lb. 50 lb.	22 lb.	
Packaged Dimensions	19"L x 12.5"W x 19.5"H	9"L x 3.5"W x 14"H		

A large sheet of blue pond liner is being laid out on a sandy ground. The liner is wrinkled and has some small brown spots on it. In the background, there is a wooden fence and some green plants.

Liner, Underlayment, and Geotextile

Liner, underlayment, and geotextile are the pond's foundation. With a large selection of liners available, it is important to always determine whether the liner you choose is safe for fish that may inhabit the pond.





Special Order Liner

Packaged Weight: .185 lb. per sq. ft.

Roll Dimensions: Special Order Only • Minimum Size of 60' x 100'

MSRP: Call for pricing

#30336

Compare 45 mil EPDM Liner Rolls*

Item Number	MSRP	Roll Dimensions	Packaged Weight
42002	\$1,345.00	5' x 100'	164 lb.
29188	\$1,345.00	10' x 50'	164 lb.
29189	\$2,690.00	10' x 100'	324 lb.
29192	\$2,017.50	15' x 50'	243 lb.
29193	\$4,035.00	15' x 100'	486 lb.
29196	\$2,690.00	20' x 50'	324 lb.
29197	\$5,380.00	20' x 100'	648 lb.
29200	\$3,362.50	25' x 50'	402 lb.
29201	\$6,725.00	25' x 100'	810 lb.
29202	\$4,035.00	30' x 50'	486 lb.
29203	\$8,070.00	30' x 100'	972 lb.
29206	\$5,380.00	40' x 50'	678 lb.
29207	\$10,760.00	40' x 100'	1,295 lb.
29210	\$6,725.00	50' x 50'	810 lb.
29211	\$13,450.00	50' x 100'	1,635 lb.

* Longer roll lengths of 150' and 200' available. Call for availability!

20-Year Guarantee

Leads the industry in quality and reliability. Exceptional resistance to solar UV, ozone, and oxidation



Safe for Fish and Plants

Free of harmful chemicals that can leach into the pond water

Easy Installation

Superior elongation and lay-flat characteristics

Compare 45 mil EPDM Boxed Liner

Item Number	MSRP	Liner Dimensions	Packaged Dimensions	Packaged Weight
85009	\$215.20	8' x 10'	12"L x 12"W x 12"H	26 lb.
29607	\$269.00	10' x 10'	20"L x 15.5"W x 9.5"H	33 lb.
85000	\$322.80	10' x 12'	16"L x 11"W x 14.5"H	39 lb.
29612	\$538.00	10' x 20'	20"L x 16"W x 13"H	65 lb.
29616	\$807.00	10' x 30'	17.5"L x 24"W x 14"H	98 lb.
85001	\$484.20	12' x 15'	18"L x 11.5"W x 14.5"H	59 lb.
85002	\$605.25	15' x 15'	20"L x 25.5"W x 15"H	74 lb.
85003	\$807.00	15' x 20'	19"L x 17"W x 19"H	98 lb.
85004	\$1,345.00	20' x 25'	21"L x 18"W x 22"H	164 lb.

Liner, Underlayment, and Geotextile

Trouble-Free Protection

Protects your pond liner from rocks, roots, and other sharp objects

Quick and Easy Installation

Lightweight, spreads easily, and has a non-slippery surface

Made from Polypropylene

Allows for any gases to escape properly



Compare Non-Woven Geotextile Underlayment Rolls

Item Number	MSRP	Liner Dimensions	Packaged Weight
30300	\$669.99	5' x 300'	59 lb.
29169	\$1,799.99	15' x 300'	200 lb.
29170	\$1,799.99	7.5' x 600'	175 lb.
29227	Call for pricing	Cut to size	0.04 lb. per sq. ft. over 900 sq. ft.



Boxed Non-Woven Geotextile Underlayment

Packaged Weight: 5.7 lb.

Underlayment Dimensions: 10' x 15'

Packaged Dimensions: 13"L x 12"W x 12"H

MSRP: \$89.98

#85010

Compare Rock Pad, Woven Microgrid Geotextile, and Concrete Cloth

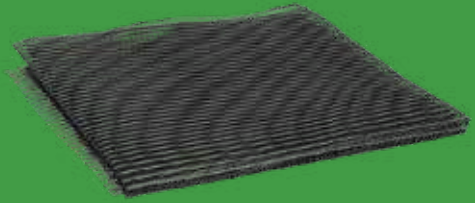

	Rock Pad 3' x 3'	Rock Pad Roll-15' x 150'	Woven Microgrid Geotextile 8' x 270'	Woven Microgrid Geotextile 4' x 4'
--	---------------------	-----------------------------	--	--

Item Number	25000	25001	42016	42015
MSRP	\$51.99	\$4,099.99	\$3,379.99	\$38.99
Packaged Weight	1.1 lb.	260 lb.	65 lb.	.5 lb.



- 1 Rock Pad**
Extra-thick, non-woven polypropylene fabric provides a significant cushion between the liner and large rocks, effectively protecting the liner from rips or tears
- 2 Woven Microgrid Geotextile**
Provides a long-lasting barrier to prevent rock and debris from entering sub-surface water reservoirs while allowing water to easily infiltrate the storage basin
- 3 EPDM Pond Liner**
The ideal membrane for retaining water in ponds, Pondless® Waterfalls, and other water features
- 4 Non-Woven Geotextile Underlayment**
Used to protect pond and water feature liner from rocks, roots, and other sharp objects that may damage the liner

Pipe and Plumbing

Complete your water feature with high quality plumbing products. Whether you're starting a new project, or updating an existing water feature, you can trust Aquascape to provide what you need to get the job done right.





Flexible PVC Pipe / Black Vinyl Tubing

High-Quality Pipe

Has the durability to be glued into standard schedule 40 PVC fittings



Flexible PVC Pipe 1" x 50' Shown

Compare Flexible PVC Pipe

Item Number	MSRP	Pipe Dimensions	Packaged Weight
48015	\$181.99	1" x 50'	14.5 lb.
29021	\$136.99	1.5" x 25'	13 lb.
29022	\$272.99	1.5" x 50'	24 lb.
29023	\$285.99	2" x 25'	14 lb.
29024	\$519.99	2" x 50'	30.75 lb.
29025	\$1,079.99	3" x 50'	31 lb.
29026	\$1,949.99	3" x 100'	118 lb.

Ideal for Recirculating Water

No need for PVC glue



Black Vinyl Tubing 1/2" x 100' Shown

Compare Black Vinyl Tubing

Item Number	MSRP	Pipe Dimensions	Packaged Weight
94008	\$168.98	3/8" x 100'	7 lb.
94009	\$181.98	1/2" x 100'	6 lb.
94010	\$285.98	3/4" x 50'	11.75 lb.

Extremely Flexible

Resistant to crimping or collapsing around tight curves



Kink-Free Pipe 1" x 100' Shown

Compare Kink-Free Pipe

Item Number	MSRP	Pipe Dimensions	Packaged Weight
98288	\$285.98	1/2" x 100'	9.25 lb.
94002	\$96.98	3/4" x 25'	3.5 lb.
94003	\$363.98	3/4" x 100'	17.75 lb.
94001	\$116.98	1" x 25'	4 lb.
94004	\$389.98	1" x 100'	16.75 lb.
94000	\$122.98	1.25" x 25'	6 lb.
94005	\$454.98	1.25" x 100'	23 lb.
94006	\$168.98	1.5" x 25'	5.75 lb.
94007	\$532.98	1.5" x 100'	38.5 lb.

Ideal for Fountain Installations

Pre-cut in convenient six-foot sections



Pre-Cut Kink-Free Pipe 1/2" x 6' Shown

Compare Pre-Cut Kink-Free Pipe

Item Number	MSRP	Pipe Dimensions	Packaged Dimensions	Packaged Weight
88003	\$32.98	1/2" x 6'	10"L x 12"W x 3/4"H	5 lb.
98404	\$36.98	3/4" x 6'	14"L x 13"W x 1"H	1 lb.

Check Valves and Flow Control Valves

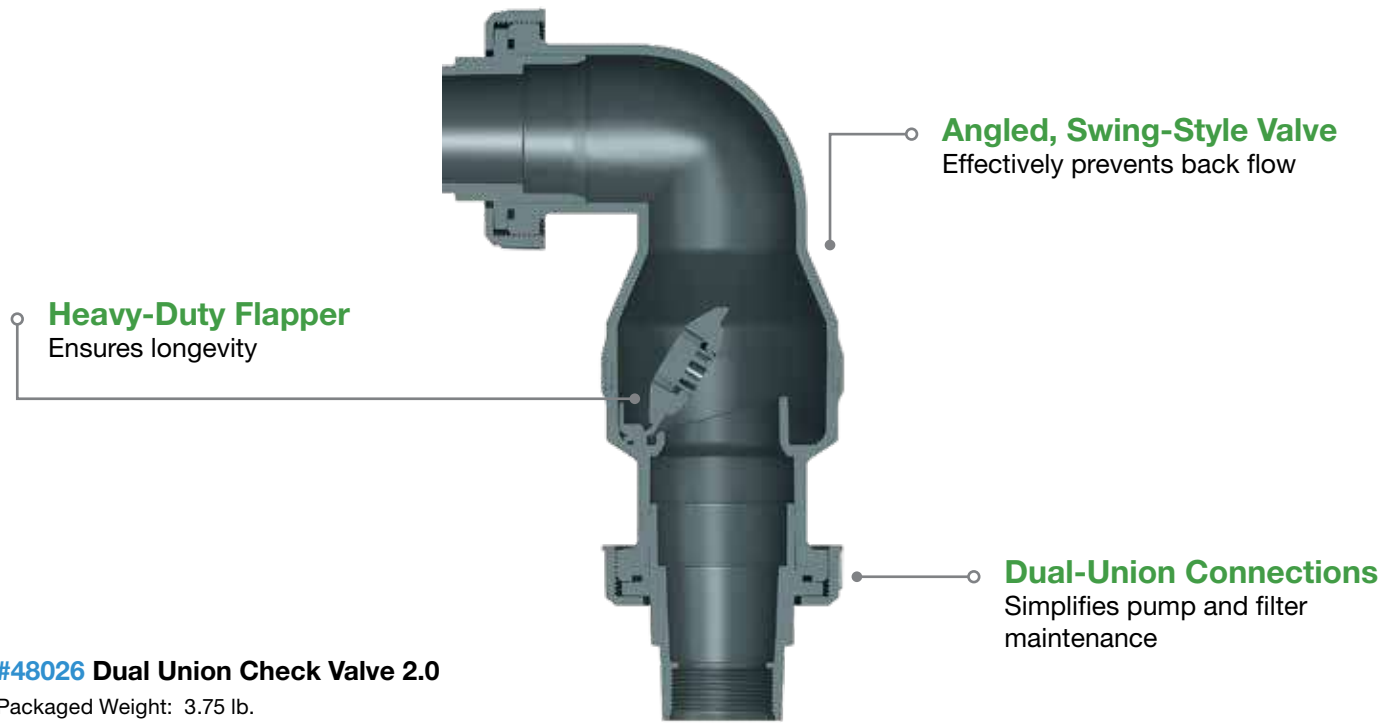

Angled, Swing-Style Valve
Effectively prevents back flow

Heavy-Duty Flapper
Ensures longevity

Dual-Union Connections
Simplifies pump and filter maintenance

#48026 Dual Union Check Valve 2.0

Packaged Weight: 3.75 lb.
Packaged Dimensions: 14"L x 9"W x 4.75"H
MSRP: \$98.99



Reversible Fittings Eliminate Guesswork



Seamless Integration

The Dual Union Check Valve 2.0 provides a professional pump and plumbing connection inside skimmer filter systems, as well as Pondless® Waterfall Vaults.

Check Valves and Flow Control Valves

PP



Dual Union 3"
Check Valve



2-Way Flow
Control Valve



Check Valve Adapter for
EcoWave® Pond Pump - 2"

Item Number	29098	88005	88058
MSRP	\$219.99	\$65.98	\$13.98
Packaged Weight	7.5 lb.	1.5 lb.	.5 lb.
Packaged Dimensions	24"L x 9"W x 9"H	9"L x 4.5"W x 8"H	3.75"L x 3.75"W x 4"H

K | F | P | A | L | PWR | WT | PC | SC | FC | APC | D | LUG | PP | IT | RH

Water Fill Valves

Automatically Adds Water to Features When Needed

Reduces the time-consuming maintenance of manually filling water features with a hose



Eliminates Large Water Chemistry Swings

Including chlorine/chloramine levels that occur during manual top-offs

Compact Water Fill Valve Shown

Compare Water Fill Valves



Compact Water Fill Valve

Water Fill Valve 200

Hudson Water Fill Valve

Item Number	88006	29272	29469
MSRP	\$62.99	\$103.98	\$116.99
Features	Small size fits in any skimmer, Pondless® Waterfall Vault, or AquaBasin.	Reliable mechanical arm-style fill valve. Brass hardware with poly float.	Mounting plate allows for 4-inch setting adjustments. Use Fill Valve Irrigation Conversion Kit (#01008) to connect to 1/2" PVC.
GPM	Up to 1.5 gal.	Up to 3 gal.	Up to 1.5 gal.
PSI	0-100		8-65
Fittings	1/4", 1/2" poly-pipe, 1/2" pvc pipe (pipe sold separately)	1/2" poly-pipe, 1/2" pvc pipe (pipe sold separately)	Quick-connect for 1/4" poly-pipe (pipe sold separately)
Packaged Weight	.75 lb.	1 lb.	1.25 lb.

Water Fill Valve Accessories

PP



Fill Valve Spigot 1/4" Quick-Connect



Garden Hose Adapter Assembly



Fill Valve Irrigation Conversion Kit



WFV Poly Pipe Roll
1/4" x 100' / 1/2" x 100'

Item Number	07000	29517	01008	29350 29470
MSRP	\$38.99	\$16.99	\$55.99	\$38.99 \$97.99
Connection	1/4" poly pipe to garden spigot	1/2" poly pipe to garden spigot	—	
Conversion	—		1/4" Hudson Water Fill Valve up to 1/2" poly pipe or PVC	—
Packaged Weight	.25 lb.		.05 lb.	1.25 lb. 5 lb.

K | F | P | A | L | PWR | WT | PC | SC | FC | APC | D | LUG | PP | IT | RH

Installation Tools

Whether you are a do-it-yourselfer or professional water feature contractor, Aquascape has all the pieces and parts you need for successful water feature installation or repair.





**Mousse noire expansive
polyuréthane**

Utiliser pour boucher les trous et remplir les vides entre les rochers.
L'écoulement de l'eau passe facilement.
C'est idéal pour les poissons et les plantes.



**For use with
Professional Foam
Guns**

**À utiliser avec les
pistolets à mousse
professionnels**

NET WT. 24 oz (680 g)

aquascape inc. USA



Pond and Waterfall
Foam Sealant



Professional
Black Waterfall Foam



Professional
Foam Gun Cleaner



Installation Kit

Item Number	82002	30096	22011	22008
MSRP	\$25.98	\$46.99	\$45.99	\$51.99
Application	Applicator straw included. No Foam Gun required	Foam Gun Applicator required	Cleans Foam Gun Applicator	Applicator straw included. No Foam Gun required
Packaged Weight	1 lb.	2 lb.	1.25 lb.	2.25 lb.



Economy Foam Gun Applicator



Professional Foam Gun Applicator



Black Silicone Sealant
4.7 oz / 10.1 oz



Clear Silicone Sealant
10.1 oz

Item Number	54003	29268	22010 29186	82000
MSRP	\$77.99	\$285.99	\$16.98 \$25.99	\$20.99
Application	Use with item #30096 & #22011		Used for sealing joints where liner attaches to BioFalls® lip and skimmer faceplate. Fish safe.	
Packaged Weight	1.5 lb.	1.25 lb.	.5 lb.	.75 lb.



Firestone® QuickSeam
Pond Liner Repair Kit



Firestone®
QuickScrubber Kit



Firestone® QuickPrime
Plus-EPDM Liner
Seaming Tape Primer

Item Number	42023	54009	54008
MSRP	\$71.99	\$77.99	\$103.99
Kit Includes	6" x 6" QuickSeam patches, bottle of LVOC primer (2 oz. / 57 ml), scrubber pad, patch roller, pair of disposable gloves	30 scrub pads, 4 holders designed for the application of Firestone® QuickPrime Plus-EPDM Liner Seaming Tape Primer	—
Packaged Weight	.5 lb.	.75 lb.	2 lb.



EPDM
Liner Patch 6"



EPDM Liner
One-Sided Cover Tape
6" x 25' / 6" x 100'



EPDM Liner
Double-Sided Seam Tape
3" x 25' / 3" x 100'



Christy's Red Hot
Blue Glue

Item Number	22018	22003 22005	22017 22020	29969
MSRP	\$18.98	\$207.99 \$454.99	\$90.99 \$246.99	\$19.99
Packaged Weight	.25 lb.	6.25 lb. 20 lb.	2 lb. 20 lb.	.4 lb.



Cleanout Pump and Discharge Hose

Great for pond cleanouts and installation wash-downs. [See page 69](#)





Rainwater Harvesting

The Aquascape Rainwater Harvesting System adds the beauty of a water feature to a rainwater collection system for capturing, filtering, and reusing our most precious resource – water! Whether you choose a Pondless Waterfall or bubbling urn to add to your landscape, you'll be happy knowing your rainwater harvesting system not only looks great but is beneficial for the environment too.



STEP 1: Choose The Water Storage System

Each Aquascape Rainwater Harvesting System Water Storage Kit includes: Pondless® Waterfall Vault Extensions(s), AquaBlox®, 45 mil EPDM Liner, and two pieces of non-woven geotextile, underlayment (one to surround the AquaBlox® and one to surround the exterior of the EPDM liner).



Compare Water Storage Kits

	500 Gallon	1000 Gallon	1500 Gallon	2000 Gallon	2500 Gallon	3000 Gallon
Item Number	30097	30099	30102	30105	30108	30112
MSRP	\$2,899.99	\$5,499.99	\$7,399.99	\$9,299.99	\$10,699.99	\$11,999.99
Basin Size	6' x 9' x 4'	6' x 9' x 5'	8' x 9' x 5'	9' x 11' x 5'	11' x 12' x 5'	9' x 11' x 6'
AquaBlox Large Water Storage Modules	16	32	48	64	80	96
45 mil EPDM Liner	15' x 20'	20' x 25'	25' x 25'	25' x 30'		
Underlayment	(2) 300 sq. ft.	(2) 500 sq. ft.	(2) 625 sq. ft.	(2) 750 sq. ft.		
Pondless Waterfall Vault Extensions	1	4				6

STEP 2: Choose The Water Feature

OPTION
1

Flexible PVC Pipe

Includes 2" 25 ft. pipe and overflow kit to manage excess water

Pondless Waterfall Vault

Perfect for pump placement and access

Waterfall Spillway

Creates the ideal starting point of the waterfall or stream

LED Lighting

Included to bring the feature to life at night

#44001 Rainwater Harvesting Pondless® Waterfall Add-On Kit

MSRP: \$4,029.99

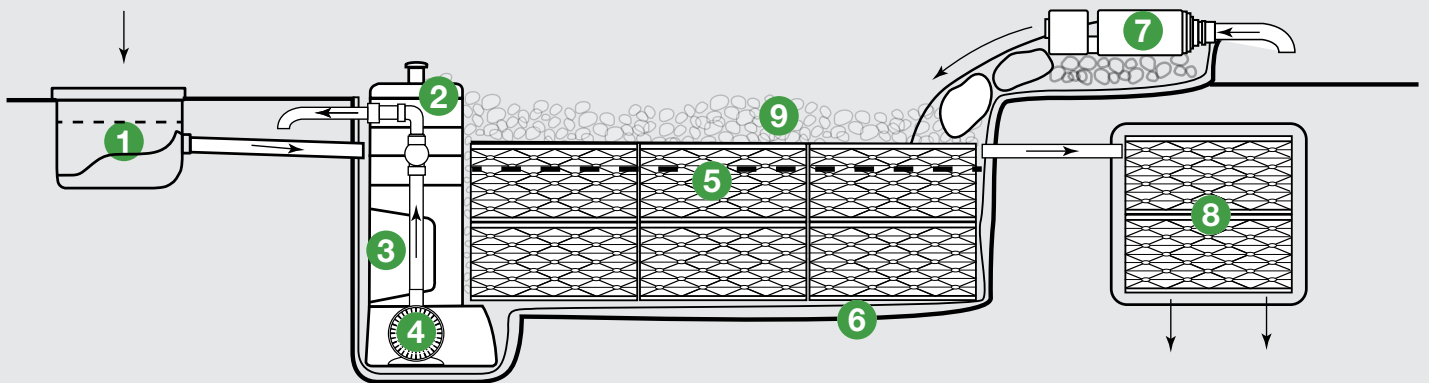

Pondless® Waterfall Components

- | | | |
|---------------------------------------|----------------------------------|----------------------|
| 1 Downspout Filter | 4 Pump | 7 Waterfall Spillway |
| 2 Pondless Waterfall Vault Extensions | 5 AquaBlox Water Storage Modules | 8 Overflow Drainage |
| 3 Pondless Waterfall Vault | 6 Liner and Underlayment | 9 Rocks and Gravel |

STEP 2: Choose The Water Feature

Pondless Waterfall Vault

Perfect for pump placement and access

Flexible PVC Pipe

Includes 2" 25 ft. pipe and overflow kit to manage excess water

OPTION
2

AquaSurge 2000-4000 Adjustable Flow Pond Pump

Provides customizable water flow rates using a handheld, wireless remote control

Smart Control Receiver

Makes it easy to connect your pump to your smartphone or tablet, allowing for wireless flow adjustment and customized scheduling

#44000 Rainwater Harvesting Fountain Add-On Kit

MSRP: \$2,274.99

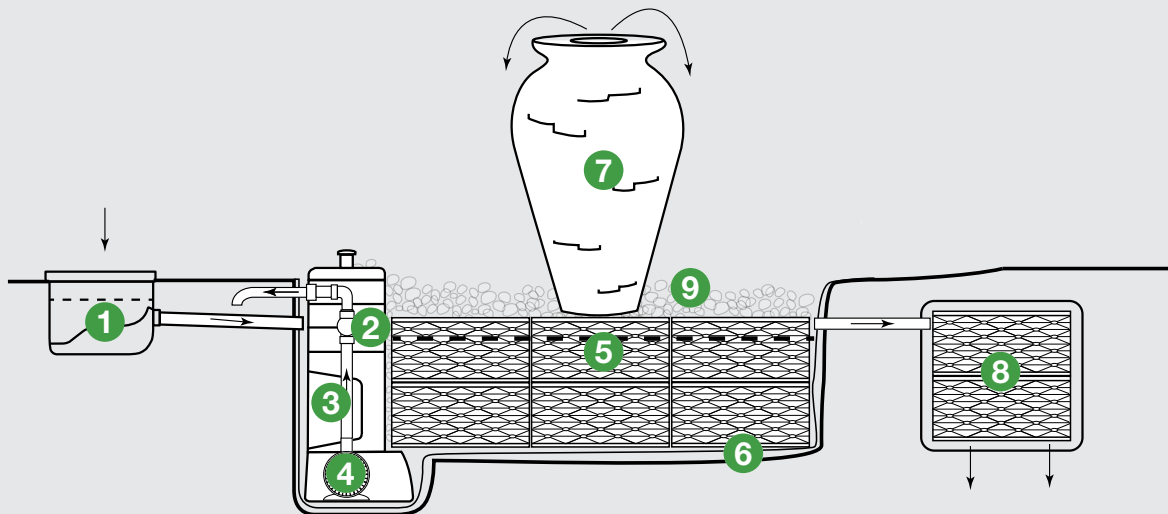

Fountain Components

- 1 Downspout Filter
- 2 Pondless Waterfall Vault Extensions
- 3 Pondless Waterfall Vault
- 4 Pump
- 5 AquaBlox Water Storage Modules
- 6 Liner and Underlayment
- 7 Decorative Fountain
- 8 Overflow Drainage
- 9 Rocks and Gravel

STEP 3: Choose The Decorative Fountain



Small Stacked
Slate Sphere



Medium
Scalloped Urn



Natural
Mongolian Basalt
Columns Set of 3



Small Stacked
Slate Urn

Item Number	78287	78239	58062	98939
MSRP	\$709.98	\$1,169.98	\$2,599.98	\$709.98
For more information, see page	162	164	166	165

For more fountain options, [see page 158-166](#)



Rainwater Harvesting Downspout Filter

Packaged Weight: 10 lb.

Packaged Dimensions: 27"L x 25.25"W x 15"H

MSRP: \$429.99

[#30166](#)



Add A Downspout Filter

The Downspout Filter is installed at the base of the downspout ready to capture rainwater and remove a variety of debris. Incoming rainwater is passed through a series of mechanical filters that remove leaves, twigs, seeds, and small sediment that accumulate on the surface of the roof between rain events. Add a Downspout Filter to any fountain or Pondless® Waterfall feature and make it sustainable!

Index

2-Outlet Pond Aeration Kit **73**
2-Way Aeration Compressor Manifold **77**
2-Way Flow Control Valve **191**
3-Light Spotlight Kit **84, 85**
4-Outlet Pond Aeration Kit **72, 73**
4-Way 3/8" Splitter with Caps **149**
10" Rubber Membrane Aeration Diffuser **76**
300-Watt Pond De-Icer **128, 130**

A

Activated Pond Carbon **111**
Add-On Pond Filters **32, 33**
– Container Water Garden Filter **33**
– Large Pond Filter Urn **32**
– Pond Waterfall Filter **32**
– Small Pond Filter Urn **32**
– Submersible Pond Filter **33**
Adjustable Flow Pump Extension Cord **50, 52, 60**
Alkalinity Booster **111**
Ammonia Neutralizer **111**
Ammonia Neutralizer Professional Grade **119**
AquaBasin® 30 **157, 163, 164, 166**
AquaBasin® 45 **18, 19, 20, 21, 58, 151, 152, 156, 157, 158, 159, 160, 161, 162, 163, 164, 165, 166**
AquaBlox® Water Storage Modules **14, 42**
AquaForce® Adjustable Flow Solids-Handling Pond Pump **60, 61**
AquaForce® Solids-Handling Pond Pump **39, 60, 61**
AquaGarden Maintenance 4-in-1 **5, 116, 168, 171**
AquaGarden Mini Pond Kit **168**
AquaGarden Plant Light **169**
AquaGarden Stand **169**
AquaGarden Tabletop Fountain Kit **170, 171**
AquaJet® Pond Pump **62, 63**
AquaSurge® Adjustable Flow Pond Pump **51**
AquaSurge® Pond Pump **50, 51**
Aquatic Lily Planter **142**
Aquatic Patio Pond Kit **173**
Aquatic Planters **142**
Automatic Dosing System **10, 11, 16, 17, 104**
Automatic Dosing System Replacement Pump Cartridge **104**
Automatic Dosing System Water Treatments **105**

B

Backyard Waterfall Landscape Fountain Kit **18, 19**
Bacteria Bubble Tabs **109**
Bamboo Fountains **174, 175**
– Adjustable Pouring Bamboo Fountain **174, 175**
– Deer Scarer Bamboo Fountain **175**
– Pouring 3-Tier Bamboo Fountain **174, 175**
Barbed Coupling 3/8" **77**
Barley Straw Extract **113**
Barley Straw Extract Professional Grade **119**
Beneficial Bacteria **108**
Beneficial Bacteria Concentrate **108**
Beneficial Bacteria Concentrate Professional Grade **118**
Beneficial Bacteria Professional Grade **118**

BioFalls® Filters **30, 31**
– Signature Series 1000 BioFalls **11, 31**
– Signature Series 2500 BioFalls **11, 31**
– Signature Series 6000 BioFalls with 2" Bulkhead **11, 31**
– Signature Series 6000 BioFalls with 3" Bulkhead **11, 31**
Black Pond Dye **115**
Black Silicone Sealant **197**
Black Vinyl Tubing **188**
Blue Heron Decoy **124**
Blue Pond Dye **115**
Boxed Non-Woven Geotextile Underlayment **184**

C

Centipede® **43**
– Large Centipede® Module **43**
Check Valve Adapter for EcoWave Pond Pump - 2" **58, 191**
Christy's Red Hot Blue Glue **199**
Cleanout Pump **69, 199**
Cleanout Pump Discharge Hose 50' **69, 199**
Clear Silicone Sealant **197**
Cold Water Beneficial Bacteria **108, 128**
Cold Water Beneficial Bacteria Professional Grade **118**
Color-Changing Fountain Light **82**
Color-Changing Fountain Light Kit **82**
Color-Changing Light Extension Cables **83**
– 3-Way Color-Changing Light Splitter **83**
– 6-Way Color-Changing Light Splitter **83**
– 25' 5-Outlet Color-Changing Light Extension Cable **83**
– 25' Color-Changing Light Extension Cable **83**
Color-Changing Light Remote **80**
Color-Changing Lights **80, 81**
– 2-Watt Color-Changing Waterfall Light **81**
– 4.5-Watt Color-Changing Spotlight **81**
– 8-Watt Color-Changing Spotlight **81**
Compact Water Fill Valve **192**
Concentrated Barley Straw Pellets **115**
Copper Test Kit **45**
Curved Stacked Slate Walls **161**

D

DecoBasin **157, 163, 164**
Decorative River Pebbles **179**
DIY Backyard Pond Kits **9**
– 4' x 6' **9**
– 6' x 8' **9**
– 8' x 11' **9**
DIY Backyard Pondless® Waterfall Kit **15**
Dosing System SL **5, 100**
Dual Union 3" Check Valve **191**
Dual Union Check Valve 2.0 **58, 190**

E

Economy Foam Gun Applicator **197**
EcoWave® Pond Pump **58, 59**
EPDM Boxed Liner **183**
EPDM Liner Double-Sided Seam Tape **199**

EPDM Liner One-Sided Cover Tape **199**
 EPDM Liner Patch **199**
 EPDM Liner Rolls **182**
 EXT Pond Pump **56, 57**
 EXT Pump Plumbing Kit **56**

F

Faux Basalt Columns **5, 25, 158, 159**
 Faux Driftwood **11, 17, 178**
 Faux Log Fish Cave **125, 178**
 Faux Oak Stump Cover **178**
 Faux Stone Fire Pit **147, 153**
 Fill Valve Irrigation Conversion Kit **193**
 Fill Valve Spigot 1/4" Quick-Connect **193**
 Filter Media **9, 11, 30, 31, 34, 35, 36**

- BioBalls Biological Filter Media **36**
- BioBalls Filter Media Net **36**
- Coarse Filter Media Roll **34**
- Dense Filter Media Roll **34**
- High Density Rigid Filter Mat **35**
- Low Density Rigid Filter Mat **35**
- Medium Density Rigid Filter Mat **35**

 Fire and Water 3-Piece Basalt Torch System **148, 167**
 Fire and Water Basalt Column Torch **149**
 Fire and Water Spillway Basin **5, 146, 151**
 Fire and Water Spillway Bowl **146, 151**
 Fire and Water Stacked Slate Sphere **146, 152**
 Fire and Water Stacked Slate Urn **147, 152**
 Fire Fountain Add-On Kit **162, 164**
 Fire Glass **154**
 Firestone® QuickScrubber Kit **198**
 Firestone® QuickSeam Pond Liner Repair Kit **198**
 Firestone® QuickPrime Plus–EPDM Liner Seaming Tape Primer **198**
 Flexible PVC Pipe **16, 19, 188, 203, 204**
 Floating Alligator Decoy **124**
 Floating Plant Island **142**
 Floating Swan Decoy **125**
 Fountain Foam Free **117**
 Fountain Maintenance **117**
 Fountain Scale Free **117**
 Fountain Shims **179**
 Fountain Spitters **176, 177**

- Lazy Frog on Lily Pad Spitter **177**
- Man in Barrel Spitter **176, 177**
- Naughty Dog Spitter **177**
- Toucan Spitter **176, 177**

G

Garden Hose Adapter Assembly **193**

H

Heavy Duty Pond Net with Extendable Handle **139**
 Heavy Duty Pond Skimmer Net with Extendable Handle **138**
 Hudson Water Fill Valve **192, 193**

I

Installation Kit **9, 11, 15, 17, 19, 196**
 IonGen™ G2 Probe Holder **45**
 IonGen™ Probe for the G2 System **45**
 IonGen™ System G2 **44**

K

KH/Alkalinity Test Kit **45**
 Kid's Pond Explorer Net **139**
 Kink-Free Pipe **9, 15, 39, 189**
 Koi Krunchies **137**
 Koi Sock Net **139**

L

Lake Bacteria **120**
 Lake Bacteria Packs **120**
 Lake Blue Dye Packs **121**
 Lake Flocculant Clarifier **121**
 Lake Phosphate Binder Packs **121**
 Lake Sludge Remover Packs **120**
 Lake Treatment Booster Packs **121**
 Landscape Fountain Kits **20, 21, 22, 23, 24, 25**

- Faux Basalt Columns Set of 3 **25**
- Medium Scalloped Urn **22, 205**
- Medium Stacked Slate Sphere **21, 23**
- Medium Stacked Slate Urn **21, 22**
- Mongolian Basalt Columns Set of 3 **24, 205**
- Spillway Bowl and Basin **23**
- Stacked Slate Spillway Wall 32" **23**

 Large Ultra Pump Fountain Head Kit **66**
 Low Suction Intake Attachment **19, 50, 58**
 Low Voltage Accessories **89**

- 3-Way Quick-Connect Splitter **89**
- 6-Way Quick-Connect Splitter **89**
- 25' 5-Outlet Quick-Connect Extension Cable **89**
- 25' Quick-Connect Extension Cable **89**

M

Match-Lit Flame Control System **148, 149**
 Mongolian Basalt Columns **166**
 Mongolian Basalt Columns Set of 3 **148, 166**

N

Non-Woven Geotextile Underlayment Rolls **184**

P

Path and Area 3-Watt LED Bulb **90**
 Path and Area Landscape Lights **90, 91**

- Dome Top Path and Area Landscape Light **91**
- Dome Top Path and Area Landscape Light 6-Pack **91**
- Hat Top Path and Area Landscape Light **90, 91**
- Hat Top Path and Area Landscape Light 6-Pack **91**

 Patio Pond Maintenance Tabs **117**

Index

- Patio Ponds **172, 173**
 - Desert Granite **172**
 - European Terra Cotta **172**
 - Green Slate **172**
 - Textured Gray Slate **173**
 - PL Solids-Handling Pond Pump **54, 55**
 - PN Solids-Handling Pond Pump **54, 55**
 - Pond Aerator Aeration Disc **72**
 - Pond Aerator Pro Check Valve **77**
 - Pond and Waterfall Foam Sealant **196**
 - Pond & Debris Clarifier **112**
 - Pond & Debris Clarifier Professional Grade **119**
 - Pond Detoxifier **111, 128**
 - Pond Detoxifier Professional Grade **119**
 - Pond Foam Free **111**
 - Pondless® Waterfall Vault **14, 15, 16, 17, 41, 45, 49, 58, 192, 203, 204**
 - Pondless® Waterfall Vault Extension **41, 202, 203**
 - Pond Net with Extendable Handle **139**
 - Pond Plant Potting Media **143**
 - Pond Powerhead **11, 64, 65, 128**
 - Pond Shark **138**
 - Pond Shark Pro **138**
 - Pond Skimmer Net with Extendable Handle **138**
 - Pond Sludge Remover Packs **110**
 - Pond Starter Bacteria **109, 128**
 - Pond Starter Bacteria Professional Grade **118**
 - Pre-Cut Kink-Free Pipe **189**
 - Premium Cold Water Fish Food Pellets **128, 136**
 - Premium Color Enhancing Fish Food Pellets **135**
 - Premium Fish Food Flakes **137**
 - Premium Staple Fish Food Pellets **128, 134**
 - Pro Air 20 Aeration Compressor **75**
 - Pro Air 60 Aeration Compressor **75**
 - Pro Air Pond Aeration Kits **74, 128**
 - Pro Air 20 **74**
 - Pro Air 60 **74**
 - Professional Black Waterfall Foam **196**
 - Professional Fish Net with Extendable Handle **139**
 - Professional Foam Gun Applicator **197**
 - Professional Foam Gun Cleaner **196**
 - Professional-Grade Pond Kits **10, 11**
 - Large Deluxe Pond Kit 21' x 26' **11**
 - Large Pond Kit 21' x 26' **11**
 - Medium Deluxe Pond Kit 11' x 16' **11**
 - Medium Pond Kit 11' x 16' **11**
 - Small Pond Kit 8' x 11' **11**
 - Professional-Grade Pondless Waterfall Kits **16, 17**
 - Large Deluxe Pondless Waterfall Kit (26' Stream) **17**
 - Large Pondless Waterfall Kit (26' Stream) **17**
 - Medium Deluxe Pondless Waterfall Kit (16' Stream) **17**
 - Medium Pondless Waterfall Kit (16' Stream) **17**
 - Small Pondless Waterfall Kit (6' Stream) **17**
 - Professional-Grade Pond Net **139**
 - Professional-Grade Pond Skimmer Net **138**
 - Propane Tank Covers **155**
 - Faux Stone **155**
 - Faux Stump **155**
 - Stainless Steel Fire Pan Cover **155**
 - Propane Tank Regulator and Hose **149**
 - Protective Pond Netting **128, 131**
 - Pump Cleaner Maintenance Solution **69**
- ## Q
- Quick-Connect Photocell with Timer **84, 89**
 - QuickFix Pond Gummy **114**
- ## R
- Rainwater Harvesting Downspout Filter **205**
 - Rainwater Harvesting Fountain Add-On Kit **204**
 - Rainwater Harvesting Pondless® Waterfall Add-On Kit **203**
 - Rainwater Harvesting System Water Storage Kits **202**
 - Rapid Clear Fine Filter Pads **113**
 - Rapid Clear Flocculant **113**
 - Rapid Clear Flocculant Professional Grade **118**
 - Recreation Ponds **12, 13**
 - Rock & Fountain Cleaner **117**
 - Rock Pad **185**
 - Rubber Gas Hose **149**
- ## S
- SAB Stream & Pond Cleaner **112**
 - SAB Stream & Pond Cleaner Professional Grade **119**
 - Scalloped Urns **164**
 - Simple Solutions Pump Top For Fountains **107**
 - Simple Solutions Pump Top For Ponds **106**
 - Simple Solutions Water Treatments **98, 99**
 - Skimmer Filters **28, 29**
 - Signature Series 200 Pond Skimmer **29**
 - Signature Series 400 Pond Skimmer **29**
 - Signature Series 1000 Pond Skimmer **29**
 - SLD Adjustable Flow Pond Pump **52, 53**
 - Sludge & Filter Cleaner **110**
 - Sludge & Filter Cleaner Professional Grade **119**
 - SL Water Treatments **5, 101**
 - Small Stacked Slate Urn Fountain Kit **163**
 - Small Ultra Pump Fountain Head Kit **66**
 - Smart Control App **4, 48, 50, 52, 60, 92, 95**
 - Smart Control Hub **4, 80, 81, 82**
 - Smart Control Plug **4, 92, 95**
 - Smart Control Receiver **4, 48, 50, 52, 60, 204**
 - Smart Pond Dosing System Controller Add-On Kit **102**
 - Smart Pond Dosing System XT **4, 102**
 - Smart Pond Thermometer **4, 128, 129**
 - Smart Pond Thermometer with Transformer **129**
 - Snorkel® **43**
 - Large Snorkel® Vault and Cap **43**
 - Large Snorkel® Vault Extension **43**
 - Special Order Liner **182**
 - Spillway Bowl, Basin, and Stand **165**

Stacked Slate Spheres **162**
Stacked Slate Urns **162, 163**
Statuary Water Pump **68**
Straight Stacked Slate Walls **160**
Submersible Pond Thermometer **129**

T

Transformers **80, 94**
Tumbled Lava Stones **154, 179**

U

UltraKlean Pond Filter Kits **39**

- UltraKlean 1500 Kit **39**
- UltraKlean 2500 Kit **39**
- UltraKlean 3500 Kit **39**

UltraKlean Pond Filters **38**

- UltraKlean 2000 **38**
- UltraKlean 3500 **38**

UltraKlear UV Clarifier **37**

- UltraKlear 1000 **37**
- UltraKlear 2500 **37**
- UltraKlear 5000 **37**

Ultra Water Pump **21, 66, 67**
Universal Remote for Adjustable Flow Pumps **50, 52, 60**
U-Shaped Ground Stakes **131**

W

Warm White Lights **86, 87**

- 1-Watt Spotlight **86, 87**
- 1-Watt Spotlight 6-Pack **87**
- 1-Watt Waterfall Light **86, 87**
- 1-Watt Waterfall Light 6-Pack **87**
- 3-Watt Spotlight **86, 87**
- 3-Watt Spotlight 6-Pack **87**
- 6-Watt Spotlight **86, 87**
- 6-Watt Spotlight 6-Pack **87**
- Fountain Light **88**
- Fountain Light Kit with Transformer **88**

Waterfall & Rock Cleaner Professional Grade **119**
Waterfall Spillway **14, 15, 17, 18, 19, 40, 203**
Water Fill Valve 200 **192**
Weighted Aeration Tubing **76**
Wetland Pond & Lake Bacteria Professional Grade **118**
WFV Poly Pipe Roll **193**
Woven Microgrid Geotextile **185**

X

XT Water Treatments **103**



Notes

K | F | P | A | L | PWR | WT | PC | SC | FC | APC | D | LUG | PP | IT | RH





1200 Creditstone Rd., Unit 1 • Concord, Ontario L4K 5T2
Toll Free: (866) 766-3426
Customer Service Fax: (905) 454-7310
Email: customerservicecanada@aquascapeinc.com

2023 Aquascape, Inc.
All Worldwide Rights Reserved.



Shop on Our
Website



Follow Us on
Facebook



Watch Us on
YouTube



Follow Us on
Instagram



Get Inspired on
Pinterest



Pondside Monthly
E-Newsletter



Aquascape Lifestyles
E-Magazine



Greg Wittstock, The Pond Guy



TEAM Aquascape



Ed The Pond Professor